



**Een serre voor iedereen.  
A chacun sa serre de jardin.  
A greenhouse for everyone.  
Ein Gewächshaus für alle.**



## 75 jaar ervaring

Janssens AluSystems uit Lier is een Belgisch productiebedrijf dat zich specialiseert in productie en distributie naar groothandel van hobbyserres, tuinkassen, tuinkamers, veranda's, orangerieën. De onderneming biedt eigen-ontwikkelde producten aan in de midden- en hogere klasse waarbij kwaliteit het doorslaggevende argument is. Door de jaren heen is er een uitgebreid dealer-netwerk uitgebouwd met export over heel Europa, Scandinavië en Amerika.

## 75 years of experience

Janssens AluSystems is a Belgian manufacturing company which specializes in developing, producing and distributing greenhouses, garden rooms, verandas, orangeries, conservatories and much more via our network of agents based across Europe and in the USA. The company markets middle and high-end products developed in-house for customers who attach paramount importance to quality and style. Over the years our company has earned a reputation for high quality design and innovation.



## 75 ans d'expérience

L'entreprise Janssens AluSystems, établie à Lier (Belgique), est spécialisée dans la production et la distribution, à destination des grossistes, de serres de jardin, d'abris de jardin, de vérandas, d'orangeries, etc.

L'entreprise propose ses propres produits de qualité hors-pair dans les catégories moyennes ou supérieures. Au fil des ans, elle s'est dotée d'un vaste réseau de revendeurs dans toute l'Europe, y compris en Scandinavie et en Amérique.

## 75 Jahre Erfahrung

Das Spezialgebiet von das Belgische unternehmen Janssens AluSystems ist die Produktion von Gewächshäusern, Orangerien und Wintergärten. Diese Konstruktionen werden über den Großhandel vertrieben. Die selbst entwickelten Produkte, bei denen die Qualität im Vordergrund steht, gehören zur mittleren und gehobenen Klasse.

Im Laufe der Jahre wurde ein umfangreiches Händlernetz für den Export in ganz Europa, Skandinavien und Amerika aufgebaut.



### **Geproduceerd volgens de nieuwste technologieën**

In onze productieafdeling met een bedrijfsruimte van 6500m<sup>2</sup> plus een nieuwe stockage ruimte van 8000m<sup>2</sup> beschikken we over een compleet geautomatiseerd machinepark en de nieuwste technologieën om de hoogste precisie te kunnen garanderen.

Hierdoor kunnen wij dagdagelijks garant klaar staan voor het afleveren van kwalitatieve producten volgens de hoogste standaard.

### **Produced using the latest technologies**

Our production department has a floor space of 6500m<sup>2</sup> plus a new storage area of 8000m<sup>2</sup> and we have completely automated machinery using the latest technology to ensure high precision and efficiency. This enables us to guarantee having products made to the highest quality standards ready for despatch every day.

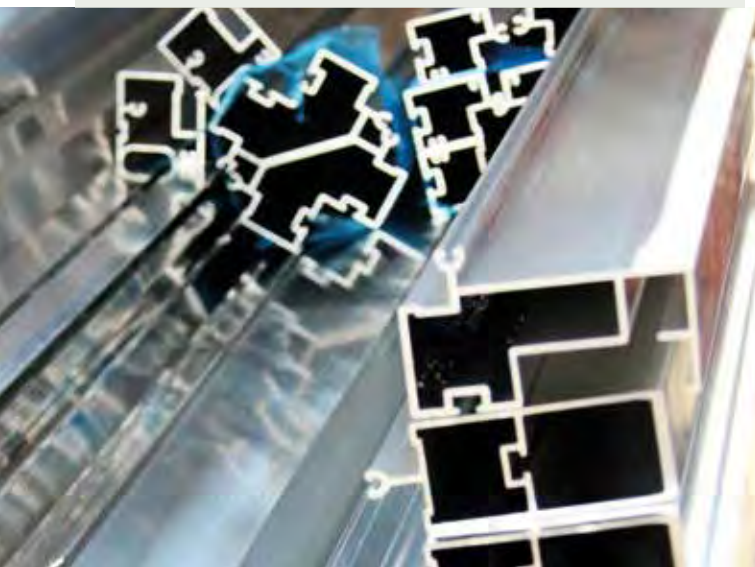



### **Fabrication utilisant les dernières technologies**

Notre atelier de production est de 6500m<sup>2</sup> et notre nouvelle surface de stockage est de 8000m<sup>2</sup>. Nos machines de dernières technologies sont entièrement automatisées et garantissent une haute précision. Cela nous permet de garantir chaque jour des produits prêts à livrer de haute qualité.

### **Die Herstellung der Konstruktionen erfolgt unter Verwendung der neuesten Technologien.**

In unserer Produktionsabteilung mit einer Fläche von 6500m<sup>2</sup> und einer neuen Lagerfläche von 8000m<sup>2</sup>, haben wir einen vollständig automatisierten Maschinenpark.

Mit den neuesten Technologien können wir die höchste Präzision gewährleisten.

Wir sind in der Lage, tagtäglich unsere Produkte mit dem höchsten Qualität herzustellen.



# Waarom kiezen voor een Janssens-tuinkas?

## Why choose a Janssens Greenhouse?

Een Aluminium constructie van topkwaliteit die garant staat voor jarenlang, onderhoudsvrij tuindersplezier. Janssens biedt een ruim gamma aan kant-en-klare tuinkassen (Action Models) maar ook de mogelijkheid tot samenstellen op maat van de klant.

Eigen ontwikkelde buisprofielen in aluminium welke tot de meest stevige en solide behoren in de hedendaagse hobby-kassenbouw. Hierdoor is het ook mogelijk om grotere- en hogere kassen aan te bieden alsook zelfdragende constructies: geen extra stalen of houten ondersteuning binnen in de kas.

A high quality aluminium frame that guarantees years of maintenance free enjoyment for gardeners. Janssens offers a wide range of standard 'off the shelf' Garden Greenhouses (Action Models), but also an extensive range of custommade Greenhouses tailored to the options chosen by the client.

Janssens' special tubular aluminium profiles that are among the most sturdy and solid in today's Hobby Greenhouse market. This also allows us to offer higher- and bigger Greenhouses as self-supporting structures: no additional steel or wooden supports inside the Greenhouse.



Aluminium de haute qualité, garantissant aux jardiniers des années d'utilisation sans entretien. Janssens livre une large gamme de serres de jardin standard (modèles promo), mais aussi une vaste gamme de serres personnalisées dont les dimensions et options sont définies par le client.

Les profilés tubulaires en aluminium Janssens sont actuellement les plus robustes sur le marché de la serre. Cela nous permet également la fabrication de serres plus hautes, plus grandes et des structures autoportantes: pas de supports supplémentaires en bois ou en acier à l'intérieur de la serre.

Aluminium-Konstruktionen mit hochwertiger Qualität garantieren jahrelangen wartungsfreien Gärtnerspaß. Janssens bietet ein große Auswahl an vorgefertigten Gewächshäusern (Aktionsmodelle). Es besteht auch die Möglichkeit, die Gewächshäuser individuell nach Kundenwunsch zu gestalten.

Eigens entwickelte geschlossene Aluminium-Kastenprofile gehören zu den stabilsten Profilen, die derzeit bei den Hobbygewächshäusern verwendet werden. Dies macht es auch möglich die Gewächshäuser höher und größer anzubieten wie auch selbsttragende Konstruktionen: keine zusätzlichen Stahl- oder Holzstützen im Inneren des Gewächshauses.

# Pourquoi choisir une serre Janssens? Warum ein Janssens-Gewächshaus wählen?

Stevig funderingsprofiel behoort tot de standaarduitrusting en kan verankerd worden in beton.

A very solid Base Profile supplied as standard. (can be anchored in concrete)

Profilé d'embase est fourni sur tous nos modèles.

Fundamentprofil gehört zur Standardausrüstung.

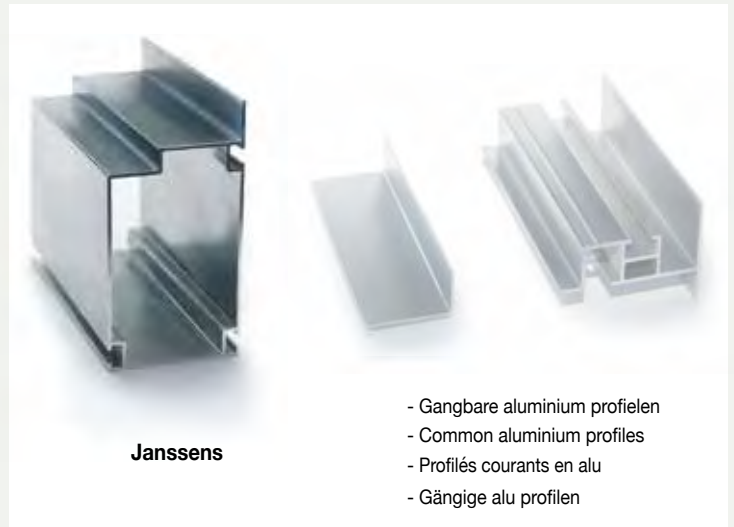
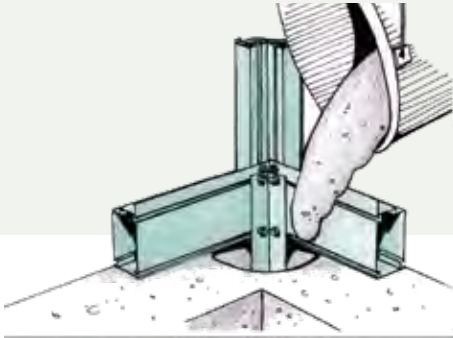

Extreem solide nokprofiel met de optie tot het aanbrengen van dakversieringen.

Extremely solid Ridge Profile with the option of applying decorative ridge cresting and finials.

Profilé de faitage extrêmement solide avec possibilité de décorations.

Sehr stabiles Firstprofil mit der Möglichkeit der Kombination mit einer Verzierung.



Beglazing met buisprofielen welke tot de meest stevige en solide behoren in de hedendaagse hobby-kassenbouw.

Tubular aluminium glazing bars that are among the most sturdy in today's Hobby Greenhouse market.

Les profilés de vitrage tubulaires sont actuellement les plus robustes sur le marché de la serre.

Verglasung mit Aluminium-Kastenprofile gehören zu den stabilsten Profilen, die derzeit bei den Hobbygewächshäusern verwendet werden.

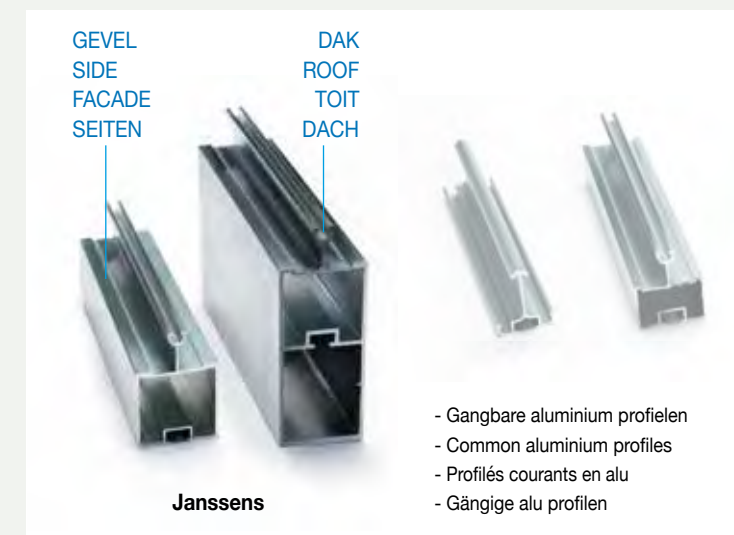

# Waarom kiezen voor een Janssens-tuinikas?

## Why choose a Janssens Greenhouse?



Gootprofiel met condens goot en waterafvoer dia 40mm worden op alle kassen standaard voorzien.

All Greenhouses are equipped with gutters, condensation channels and water downpipes dia 40mm.

Profilé de gouttière large, équipé d'un canal pour l'évacuation de la condensation et des descentes de gouttières de dia 40mm.

Alle Gewächshäuser sind mit Rinnenprofil, Kondenswasser rinne und Regenwasserablauf dia 40mm ausgestattet



Beglazing met rubber-strippen met anti-rekdraad voor optimale water- en winddichtheid.

Glazing is done by rubber strips for optimal water and wind proofing.

Vitrage fixé à l'aide de joints néoprène pour une étanchéité optimale à l'eau et au vent.

Verglasung erfolgt mit einer Gummidichtung für eine optimale Regen- und Winddichtigkeit.



Alle bevestigingsmaterialen worden geleverd in roestvrij staal.

All fittings, bolts and nuts are supplied in stainless steel.

Visserie en acier inoxydable.

Alle Verbindungen und das Verschraubungsmaterial wird aus Edelstahl geliefert.

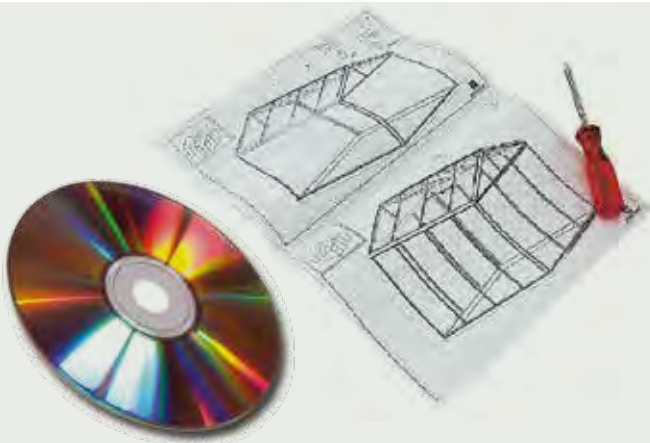

Alle modellen (met uitzondering van de custom-modellen) worden voorzien van een stap-voor-stap opbouw instructie + montagevideo om u wegwijs te maken tijdens de opbouw.

All models (except for custom-models) are supplied with a step-by-step manual + mounting video.

Tous les modèles sont livrés avec manuel et vidéo de montage.

Jedes Model (außer sondermodelle) wird geliefert mit Aufbauanleitung und Montagevideo.



# Pourquoi choisir une serre Janssens? Warum ein Janssens-Gewächshaus wählen?

Het lakwerk door middel van poedercoating geniet een lange levensduur en is volgens Qualicoat-norm.

The paintwork is always done by means of high quality powder coating with a long service life to the Qualicoat norm.

Peinture thermo laquée de haute qualité ayant une longue durée de vie avec la norme Qualicoat.

Die Lackierung erfolgt immer durch Pulverbeschichtung mit langer Lebenserwartung nach Qualicoat Normierung.



TUV-keuring op de meest verkochte modellen.

TUV (Quality Certification) approval on the best-selling models.

Nos modèles les plus vendus sont certifiés TUV.

TÜV-Freigabe für die meistverkauften Modelle.



13 jaar aflopende garantie op mogelijke productiefouten in het aluminium frame. Op alle bewegende onderdelen krijgt u 1 jaar garantie. Deze garantie omvat het kosteloos naleveren van de materialen en sluit andere kosten zoals arbeid uit.

13 years limited warranty on production failures in the aluminium frame. All moving parts are given 1 year warranty. This warranty covers the supply of materials and excludes other costs such as labor.

13 ans de garantie limitée sur des défauts de production dans le châssis en aluminium. On prévoit une garantie d'un an sur toutes les pièces mobiles. Cette garantie couvre la fourniture gratuite des matériaux nécessaires et exclue d'autres coûts tels que le travail.

13 Jahre abnehmende und beschränkte Gebrauchsgarantie auf Produktionsfehler in dem Aluminiumrahmen.

Alle beweglichen Teile haben 1 Jahr beschränkte Garantie. Diese Garantie umfasst die Lieferung von ersatz-Materialien und schließt Kosten wie Arbeit aus.



## Beglazing: gehard veiligheidsglas 4mm

In een markt waar 3mm glas nog gangbaar is, zijn alle JANSSENS-tuinkassen standaard uitgerust met 4mm gehard veiligheidsglas, de meest ideale keuze voor een tuinkas!

Glas is onderhoudsvrij en gaat jarenlang mee. Het glas wordt niet gestapeld maar steeds uit 1 stuk voorzien! Gehard glas is tot 6x sterker dan gewoon glas en meer bestand tegen slijtage. De kans op breuk of doorslag verminderd zienderogen, bovendien breekt het glas in duizend stukjes zodat risico op verwonding bij breuk erg klein is. De geslepen randen garanderen een vlotte montage en vermijden snijwonden. Kwaliteit en veiligheid boven alles!

## Vitrage : Verre trempé 4mm

Dans un marché où le verre de 3mm est encore répandu, toutes les serres JANSSENS sont équipées de verre trempé de 4mm (standard). Le verre est sans entretien et durera des années. Les panneaux de verre fournis ne se chevauchent pas mais sont d'un seul tenant !

Celui-ci est jusqu'à 6 fois plus résistant que le verre ordinaire. Ce qui minimise la casse, d'ailleurs, si le verre se brise, il le fera en milliers de morceaux ne présentant pas ou peu de parties tranchantes afin que le risque de blessure soit très faible. Tous les bords des verres sont polis pour faciliter le montage et pour éviter les coupures.

La qualité et la sécurité avant tout !

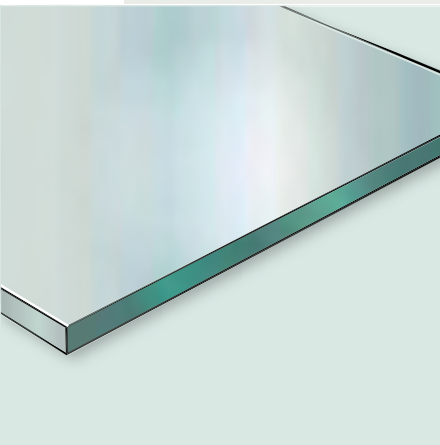

## Glazing: 4mm toughened safety glass

In a market where 3mm glass is still prevalent, all JANSSENS greenhouses are supplied with 4mm toughened glass by default. Glass is maintenance free and will last for years. Our glass is supplied where possible in full length panes rather than small overlapping panes.

This glass is to 6 times stronger than ordinary glass and more resistant to wear. Chances of breakage are greatly diminished, moreover, the glass breaks into thousands of pieces so that risk of injury when a breakage occurs is remote. All edges are polished to ensure ease of assembly and to avoid cuts. Quality and safety first!

## Verglasung: 4mm Einscheiben- Sicherheitsglas

In einem Markt, in dem 3mm Glas immer noch weit verbreitet ist, sind alle Janssens Gewächshäuser Standard mit 4 mm Einscheiben-Sicherheitsglas ausgestattet. Glas ist wartungsfrei und bleibt immer gleich. Die Verglasung erfolgt nicht mit überlappenden Scheiben sondern es wird immer in ganzen Scheiben verglast!

Dieses Glas ist bis zu 6 mal stärker als normales Glas. Im Fall eines Schadens zerkrümelt das Glas und es besteht nicht die Gefahr, dass man sich durch Schnitte verletzt, weil keine Scherben entstehen. Alle Kanten sind poliert, um eine reibungslose Montage zu gewährleisten und Schnitte zu vermeiden.

## Beglazing: Polycarbonaat 10mm

Janssens biedt naast glas ook de mogelijkheid om voor 10mm polycarbonaatplaten te kiezen bij de beglazing van de aluminium tuinkassen.

Polycarbonaat heeft een aantal voordelen ten opzichte van glas en wordt soms verplicht door de overheid.

Hét grote voordeel is uiteraard de extra isolatie tijdens de winter. Deze beglazing verspreidt een diffuus licht en biedt

sommige planten bescherming tegen UV-stralen.

Daarnaast is het een materiaal dat niet breekbaar is en erg licht van gewicht wat een voordeel kan zijn bij de montage en transport.

## Vitrage: Polycarbonate 10mm

En plus du verre trempé, Janssens offre également en option du polycarbonate de 10 mm.

Le Polycarbonate a plusieurs avantages par rapport au verre et est parfois exigé par les autorités locales.

Le principal avantage est bien sûr une isolation thermique supplémentaire pendant l'hiver. Ce vitrage diffuse la lumière et offre une certaine protection aux plantes contre les rayons UV.

En outre, c'est un matériau qui n'est pas fragile et est très léger, ce qui peut constituer un avantage lors de l'assemblage et du transport.

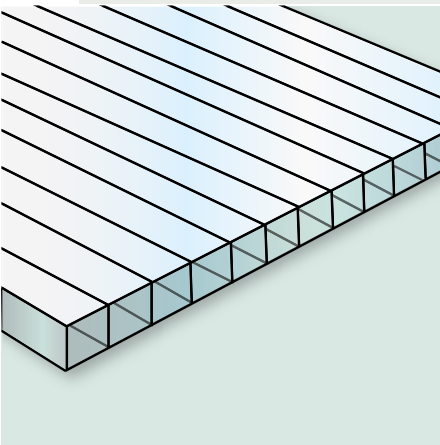

## Glazing: Polycarbonate 10mm

In addition to Toughened Glass Janssens offer the possibility to opt for 10mm polycarbonate sheets to glaze our aluminium Garden Greenhouses.

Polycarbonate has a number of advantages over glass and is sometimes required by local authorities. The big advantage of course is the extra insulation during the winter.

This glazing diffuses light (reducing sun scorch) and provides some plants protection against UV rays. In addition, Polycarbonate is not at all fragile and very light in weight which can be an advantage during assembly and transport.

## Verglasung: Polycarbonat 10mm

Neben Glas, bietet Janssens auch die Möglichkeit sich für 10mm Polycarbonat-Platten als Verglasung der Gewächshäuser zu entscheiden. Polycarbonat hat eine Reihe von Vorteilen gegenüber Glas und wird in bestimmten Ländern vorgeschrieben. Ein Vorteil ist natürlich die zusätzliche Isolierung im Winter.

Durch diese Verglasung entsteht diffuses Licht und es bietet einigen Pflanzen Schutz vor UV-Strahlen. Darüber hinaus ist es ein Material, das schlagzäh und sehr leicht im Gewicht ist, was ein Vorteil bei Montage und Transport sein kann.

# Opties & Accessoires



RAL I: 7016 - 9010- 3011  
5011- 9006  
RAL II: all other colors

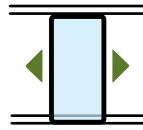
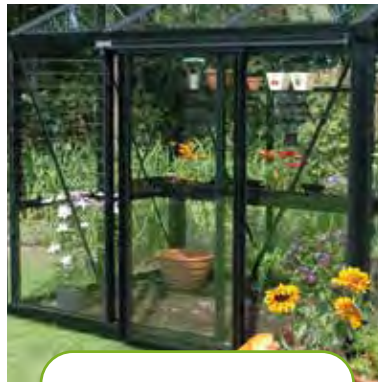

SD

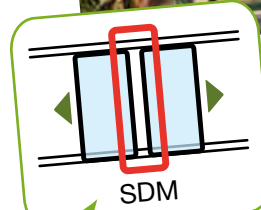

SDM

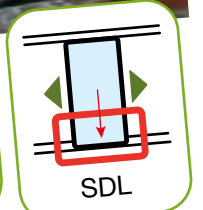

SDL

**ADD ONS !**

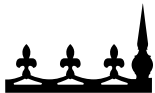

FREEZE

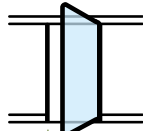
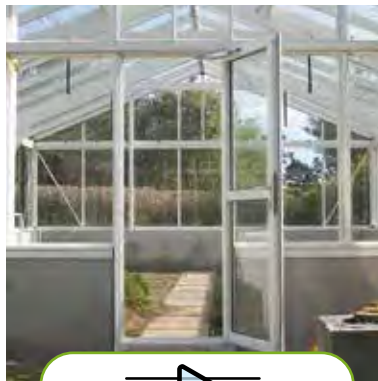

HD

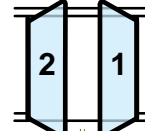

HDD

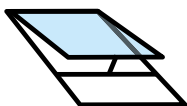
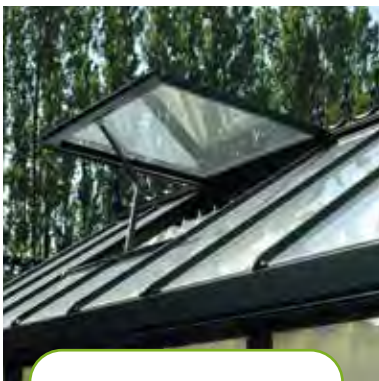

RW

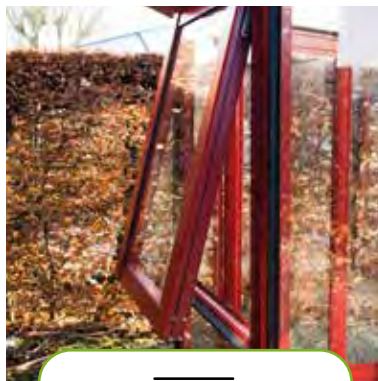

TW

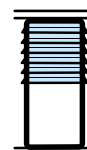
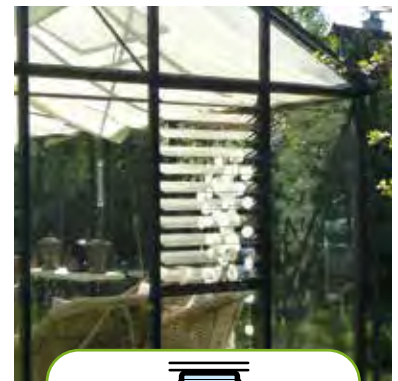

LV

# Options & Accessoires



DECOR1

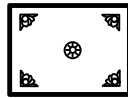
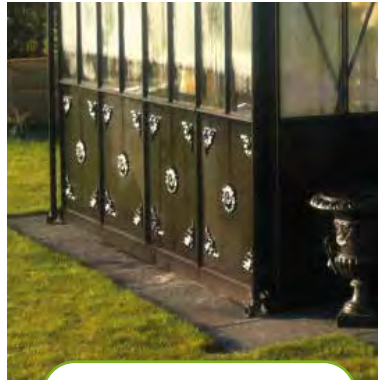

DECOR2



SUN  
L = 300 cm

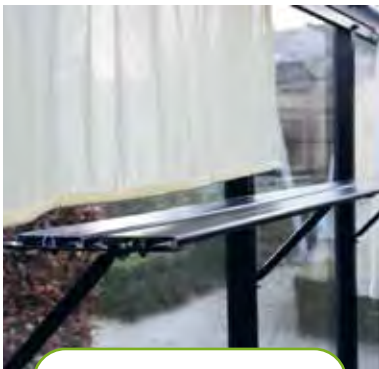

TAB2  
L = 150 cm



TAB5  
L = 150 cm



ST  
L = 236 cm / 310 cm  
458 cm / 606 cm

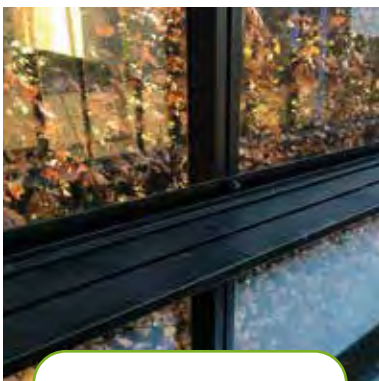

SH  
L = 236 cm / 310 cm  
458 cm / 606 cm

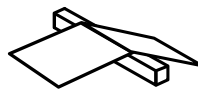
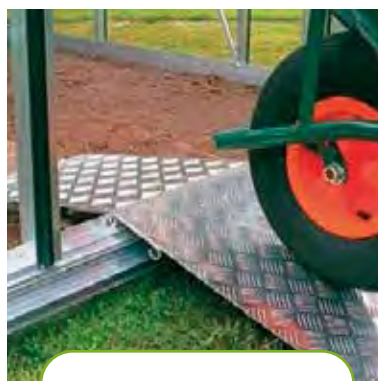

AP

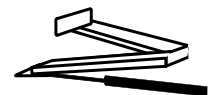
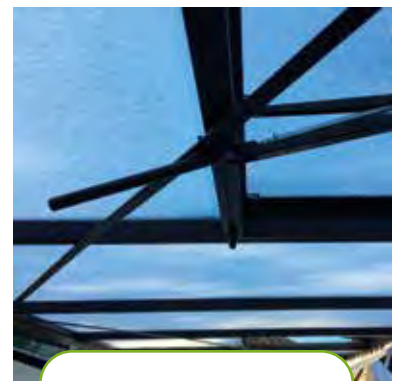

RW AUT  
LV AUT

# Eos Junior 160/40°



## Junior Hobby

\*Aanbieding: geen aanpassingen mogelijk! • Offre avec des options limitées! • Promo-model mit beschrante Möglichkeiten! • Set package with limited options!

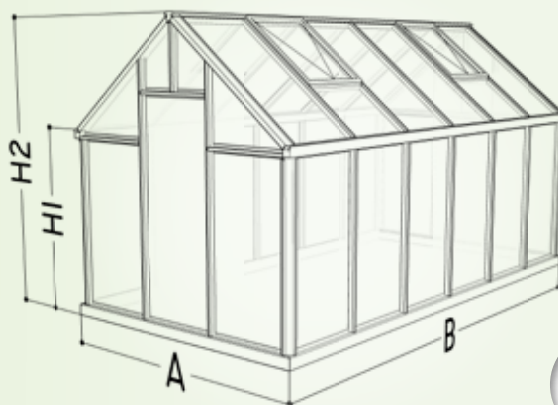
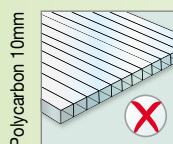
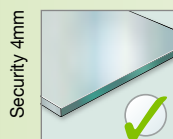

**DIY** Mounting difficulty

EASY 1 2 3 COMPLEX

✓ 2

Type	A (cm) x B(cm)	M <sup>2</sup>	H1(cm)	H2(cm)	xx°		
JH23	236 cm x 310 cm	7,3m <sup>2</sup>	161 cm	256 cm	38 °	1	1
JH24	236 cm x 384 cm	9,1m <sup>2</sup>	161 cm	256 cm	38 °	1	2
JH25	236 cm x 458 cm	10,8m <sup>2</sup>	161 cm	256 cm	38 °	1	2



# Junior Victorian

\*Aanbieding: geen aanpassingen mogelijk! • Offre avec des options limitées! • Promo-model mit beschrante Möglichkeiten! • Set package with limited options!

Color **RAL 9005**

Security 4mm

Polycarbon 10mm

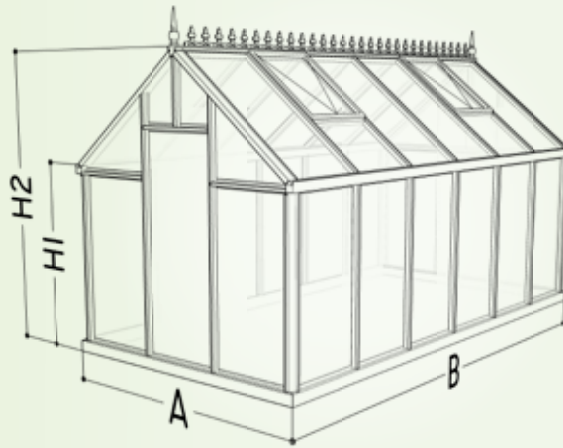

**DIY** Mounting difficulty  
 EASY 1 2 3 COMPLEX

Type	A (cm) X B(cm)	M <sup>2</sup>	H1(cm)	H2(cm)	xx°		
JV23	236 cm x 310 cm	7,3m <sup>2</sup>	161 cm	256 cm	38 °	1	1
JV24	236 cm x 384 cm	9,1m <sup>2</sup>	161 cm	256 cm	38 °	1	2
JV25	236 cm x 458 cm	10,8m <sup>2</sup>	161 cm	256 cm	38 °	1	2

✓ Included    ✓ Optional    ✗ Not available

# Eos Junior 160/40°



## Junior T•model

\* Aanbieding: geen aanpassingen mogelijk! • Offre avec des options limitées! • Promo-model mit beschränkte Möglichkeiten! • Set package with limited options!

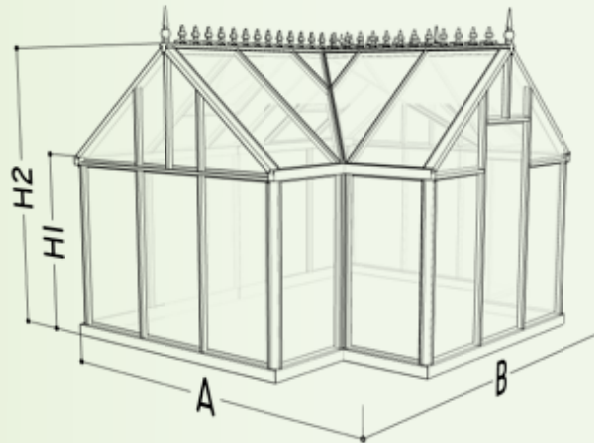
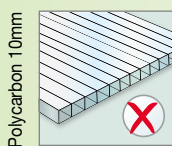
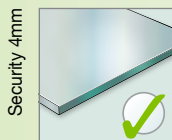
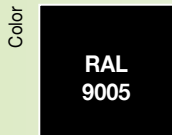

**DIY** Mounting difficulty

EASY 1 2 COMPLEX

Type	A (cm) x B (cm)	M <sup>2</sup>	H1 (cm)	H2 (cm)	xx°		
------	-----------------	----------------	---------	---------	-----	--	--

JTSL	318 cm x 401 cm	12,8m <sup>2</sup>	161cm	256 cm	38 °	1	2
------	-----------------	--------------------	-------	--------	------	---	---

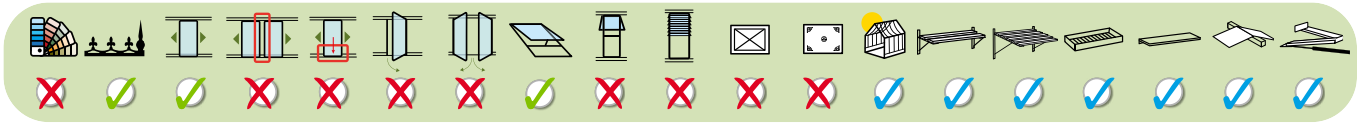

✓ Included    
 ✓ Optional    
 ✗ Not available





# Eos Royal T-Model 180/40°



## Eos Royal/Mur

\*Aanbieding: geen aanpassingen mogelijk! • Offre avec des options limitées! • Promo-model mit beschrante Möglichkeiten! • Set package with limited options!

Color

RAL  
9005

RAL  
9010

DIY Mounting difficulty

EASY 1 2 3 COMPLEX

Security 4mm

Polycarbon 10mm

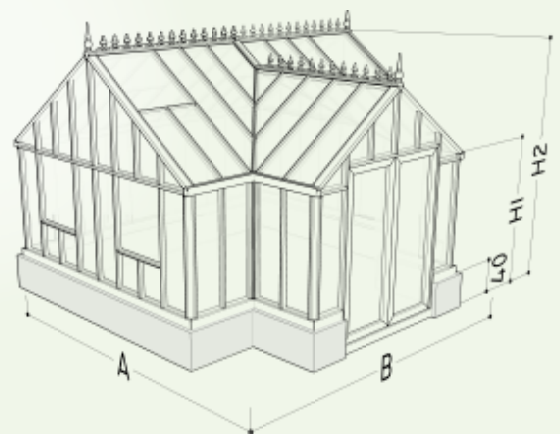
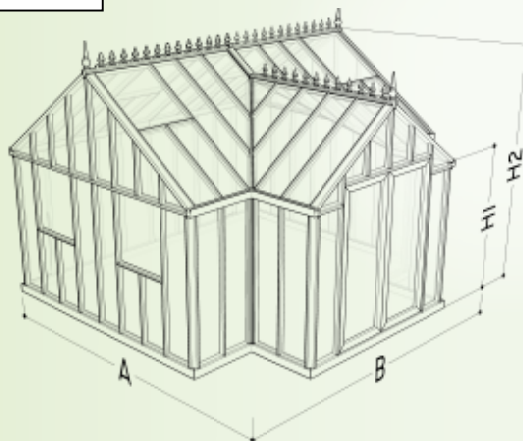

Type	A (cm) X B(cm)	M <sup>2</sup>	H1 (cm)	H2 (cm)				
RT32SL	392 cm X 401 cm	15,7 m <sup>2</sup>	181 cm	294 cm	38 °	1	4	2
RT32MSL	392 cm X 401 cm	15,7 m <sup>2</sup>	181 cm	294 cm	38 °	1	4	2

✓ Included      ✓ Optional      ✗ Not available



# Eos 200/40°



# Eos Hobby

Color  
ALU  
(no color)

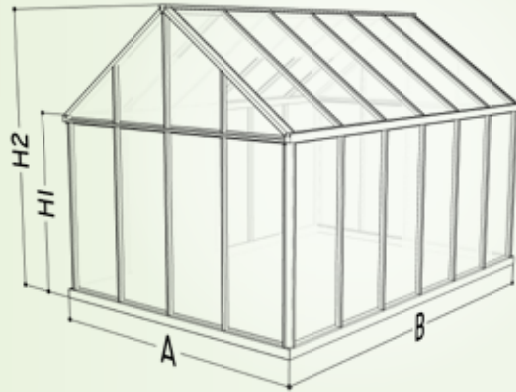
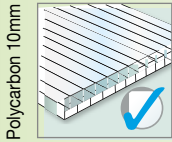
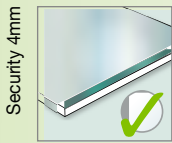

**DIY** Mounting difficulty  
EASY 1 2 3 COMPLEX

Type	A (cm) X B(cm)	M <sup>2</sup>	H1 (cm)	H2(cm)	xx°		
EH22	236 cm X 236 cm	5,6 m <sup>2</sup>	201 cm	296 cm	38 °	-	-
EH23	236 cm X 310 cm	7,3 m <sup>2</sup>	201 cm	296 cm	38 °	-	-
EH2E	236 cm X 73 cm	1,7 m <sup>2</sup>	-	-	-	-	-
EH33	310 cm X 310 cm	9,6 m <sup>2</sup>	201 cm	314 cm	37 °	-	-
EH34	310 cm X 458 cm	14,2 m <sup>2</sup>	201 cm	314 cm	37 °	-	-
EH36	310 cm X 606 cm	18,8 m <sup>2</sup>	201 cm	314 cm	37 °	-	-
EH3E	310 cm X 73 cm	2,3 m <sup>2</sup>	-	-	-	-	-

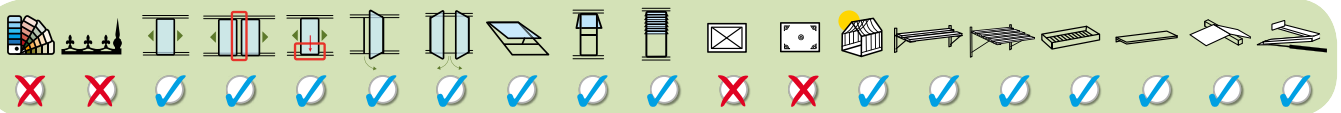

# Eos Victorian

Color  
RAL 9005  
RAL 6009

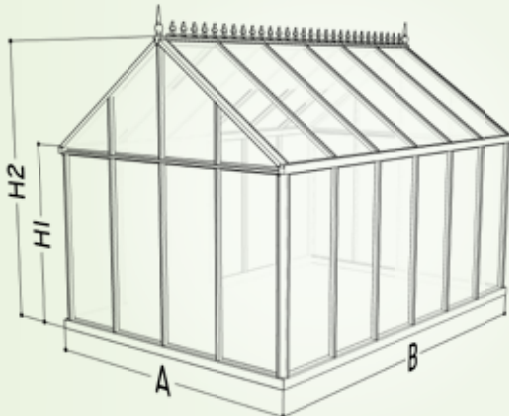
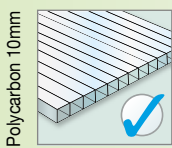
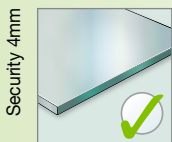

**DIY** Mounting difficulty  
EASY 1 2 3 COMPLEX

Type	A (cm) X B(cm)	M <sup>2</sup>	H1 (cm)	H2(cm)	xx°		
EV22	236 cm X 236 cm	5,6 m <sup>2</sup>	201 cm	296 cm	38 °	-	-
EV23	236 cm X 310 cm	7,3 m <sup>2</sup>	201 cm	296 cm	38 °	-	-
EV2E	236 cm X 73 cm	1,7 m <sup>2</sup>	-	-	-	-	-
EV33	310 cm X 310 cm	9,6 m <sup>2</sup>	201 cm	314 cm	37 °	-	-
EV34	310 cm X 458 cm	14,2 m <sup>2</sup>	201 cm	314 cm	37 °	-	-
EV36	310 cm X 606 cm	18,8 m <sup>2</sup>	201 cm	314 cm	37 °	-	-
EV3E	310 cm X 73 cm	2,3 m <sup>2</sup>	-	-	-	-	-

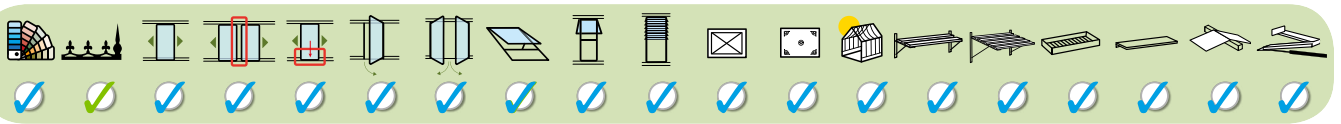

Included    Optional    Not available

# Eos 200/40°



## Eos Retro

Color

RAL  
9005

RAL  
6009

Security 4mm

Polycarbon 10mm

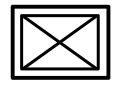
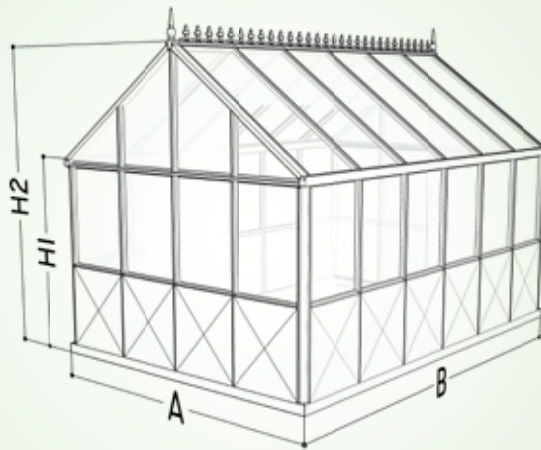

DECOR1

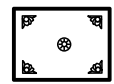

DECOR2

**DIY** Mounting difficulty

EASY 1 2 3 COMPLEX

Type	A (cm) X B(cm)	M <sup>2</sup>	H1(cm)	H2(cm)	XX°		
------	----------------	----------------	--------	--------	-----	--	--

ER22	236 cm X 236 cm	5,6 m <sup>2</sup>	201 cm	296 cm	38 °	-	-
ER23	236 cm X 310 cm	7,3 m <sup>2</sup>	201 cm	296 cm	38 °	-	-
ER2E	236 cm X 73 cm	1,7 m <sup>2</sup>	-	-	-	-	-
ER33	310 cm X 310 cm	9,6 m <sup>2</sup>	201 cm	314 cm	37 °	-	-
ER34	310 cm X 458 cm	14,2 m <sup>2</sup>	201 cm	314 cm	37 °	-	-
ER36	310 cm X 606 cm	18,8 m <sup>2</sup>	201 cm	314 cm	37 °	-	-
ER3E	310 cm X 73 cm	2,3 m <sup>2</sup>	-	-	-	-	-

✓ Included    ✓ Optional    ✗ Not available



## Eos Mur

Color

RAL  
9005

RAL  
6009

Security 4mm

Polycarbon 10mm

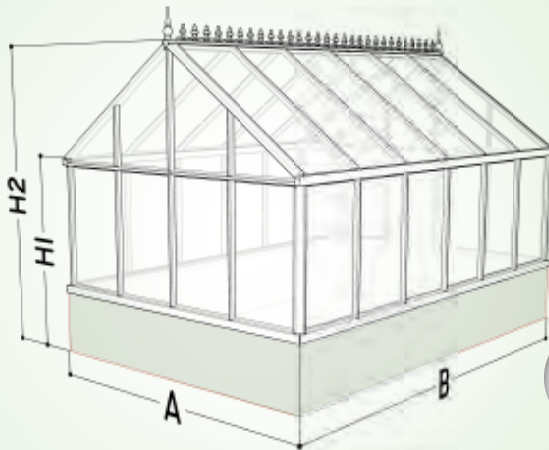

**DIY** Mounting difficulty

EASY 1 2 3 COMPLEX

Type	A (cm) X B(cm)	M <sup>2</sup>	H1(cm)	H2(cm)	XX°		
EM22	236 cm X 236 cm	5,6 m <sup>2</sup>	201 cm	296 cm	38 °	-	-
EM23	236 cm X 310 cm	7,3 m <sup>2</sup>	201 cm	296 cm	38 °	-	-
EM2E	236 cm X 73 cm	1,7 m <sup>2</sup>	-	-	-	-	-
EM33	310 cm X 310 cm	9,6 m <sup>2</sup>	201 cm	314 cm	37 °	-	-
EM34	310 cm X 458 cm	14,2 m <sup>2</sup>	201 cm	314 cm	37 °	-	-
EM36	310 cm X 606 cm	18,8 m <sup>2</sup>	201 cm	314 cm	37 °	-	-
EM3E	310 cm X 73 cm	2,3 m <sup>2</sup>	-	-	-	-	-

✓ Included    
 ✓ Optional    
 ✗ Not available

# Eos 200/40°



## Eos T•model

Color

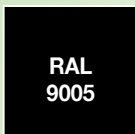

Security 4mm

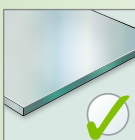

Polycarbon 10mm

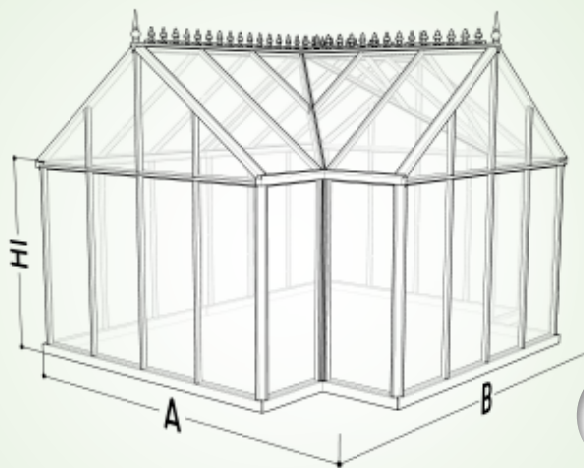
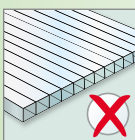

**DIY** Mounting difficulty

EASY 1 2 3 COMPLEX

Type	A (cm) X B(cm)	M <sup>2</sup>	H1 (cm)	H2 (cm)	xx°		
------	----------------	----------------	---------	---------	-----	--	--

ET23	318 cm X 401 cm	12,8 m <sup>2</sup>	201 cm	296 cm	38°	-	-
ET2E	236 cm X 73 cm	1,7 m <sup>2</sup>	-	-	-	-	-
ET34	392 cm X 476 cm	17,2 m <sup>2</sup>	201 cm	314 cm	37°	-	-
ET3E	310 cm X 73 cm	2,3 m <sup>2</sup>	-	-	-	-	-

Included    
 Optional    
 Not available





# Helios Urban 180/25°



## Helios Urban Hobby

\*Aanbieding: geen aanpassingen mogelijk! • Offre avec des options limitées! • Promo-model mit beschränkte Möglichkeiten! • Set package with limited options!

Color  
ALU  
(no color)

Security 4mm

Polycarbon 10mm

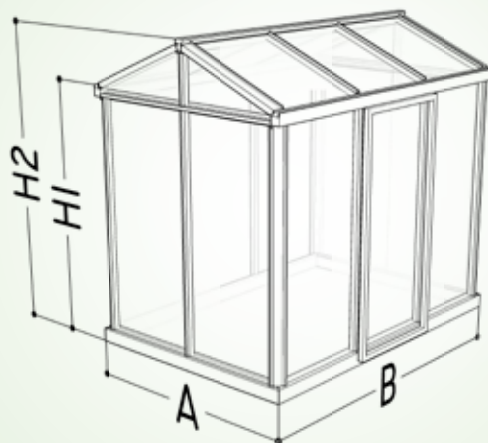

DIY Mounting difficulty  
EASY 1 2 3 COMPLEX

Type	A (cm)	x	B(cm)	M <sup>2</sup>	H1(cm)	H2(cm)				
UH12	162 cm	x	236 cm	3,8 m <sup>2</sup>	181 cm	217 cm	23 °	1	-	1

✗	✗	✓	✗	✗	✗	✗	✗	✗	✗	✓	✗	✗	✗	✓	✓	✓	✓	✓	✓
✓ Included	✓ Optional	✗ Not available																	



# Helios Urban Victorian

\*Aanbieding: geen aanpassingen mogelijk! • Offre avec des options limitées! • Promo-model mit beschrante Möglichkeiten! • Set package with limited options!

Color

RAL  
9005

RAL  
6009

Security 4mm

Polycarbon 10mm

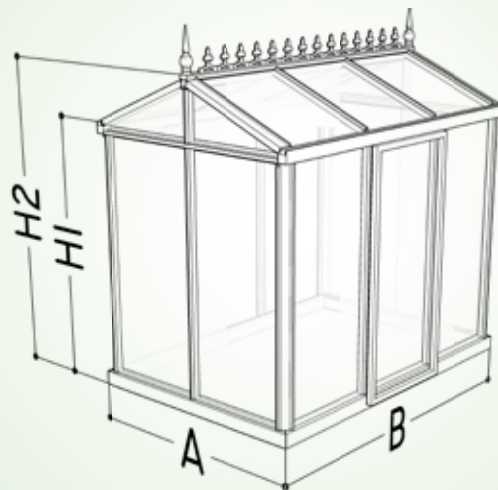

**DIY** Mounting difficulty

EASY 1 2 3 COMPLEX

✓ 1 2 3

Type	A (cm)	x	B (cm)	M <sup>2</sup>	H1 (cm)	H2 (cm)	xx°			
UV12	162 cm	x	236 cm	3,8 m <sup>2</sup>	181 cm	217 cm	23 °	1	-	1

✗	✓	✓	✗	✗	✗	✗	✗	✗	✗	✗	✗	✗	✗	✓	✓	✓	✓	✓	✓	✓
✓ Included	✓ Optional	✗ Not available																		

# Helios Senior 180/25°



## Helios Senior Hobby

\* Aanbieding: geen aanpassingen mogelijk! • Offre avec des options limitées! • Promo-model mit beschränkte Möglichkeiten! • Set package with limited options!

Color  
ALU  
(no color)

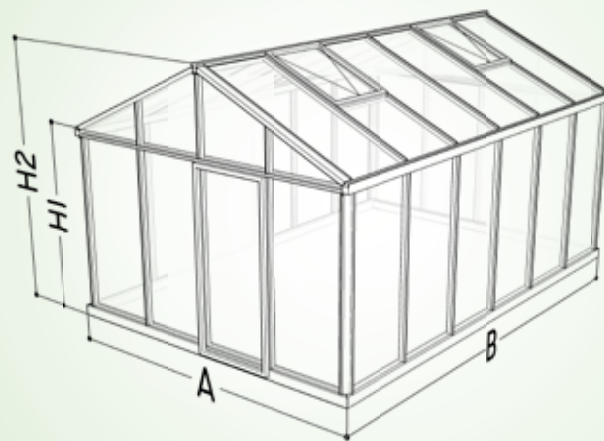
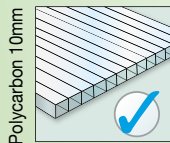
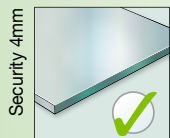

Type	A (cm) x B(cm)	M <sup>2</sup>	H1(cm)	H2(cm)	xx°			
------	----------------	----------------	--------	--------	-----	--	--	--

SH23	236 cm x 310 cm	7,3 m <sup>2</sup>	181 cm	240 cm	25 °	1	1	-
SH24	236 cm x 458 cm	10,8 m <sup>2</sup>	181 cm	240 cm	25 °	1	2	-
SH34	310 cm x 458 cm	14,2 m <sup>2</sup>	181 cm	254 cm	25 °	1	2	-
SH36	310 cm x 606 cm	18,8 m <sup>2</sup>	181 cm	254 cm	25 °	1	3	-

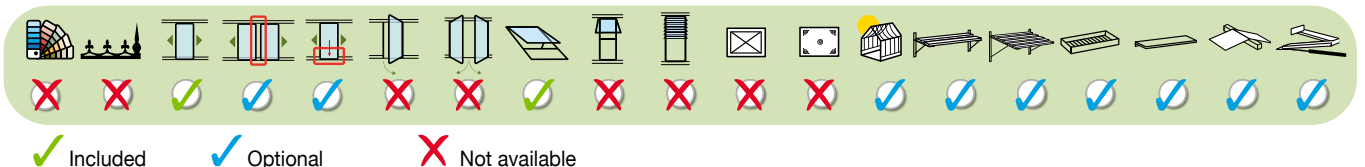



# Helios Senior Victorian

\*Aanbieding: geen aanpassingen mogelijk! • Offre avec des options limitées! • Promo-model mit beschränkten Möglichkeiten! • Set package with limited options!

Color

RAL  
9005

RAL  
6009

Security 4mm

Polycarbon 10mm

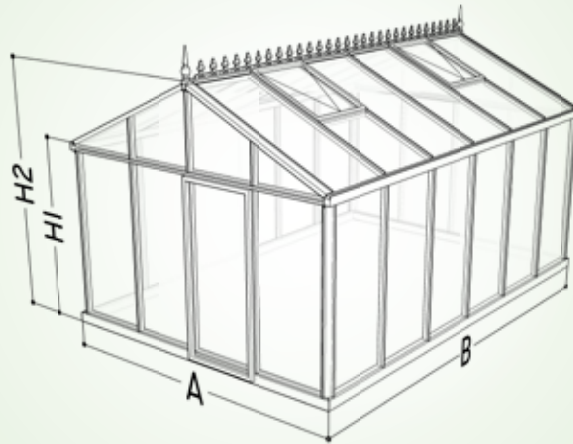

**DIY** Mounting difficulty

EASY 1 2 3 COMPLEX

✓ 1 2 3

Type	A (cm) X B(cm)	M <sup>2</sup>	H1(cm)	H2(cm)	xx°			
------	----------------	----------------	--------	--------	-----	--	--	--

SV23	236 cm X 310 cm	7,3 m <sup>2</sup>	181 cm	240 cm	25 °	1	1	-
SV24	236 cm X 458 cm	10,8 m <sup>2</sup>	181 cm	240 cm	25 °	1	2	-
SV34	310 cm X 458 cm	14,2 m <sup>2</sup>	181 cm	254 cm	25 °	1	2	-
SV36	310 cm X 606 cm	18,8 m <sup>2</sup>	181 cm	254 cm	25 °	1	3	-

✗	✓	✓	✓	✓	✗	✗	✓	✗	✗	✗	✗	✗	✓	✓	✓	✓	✓	✓
✓ Included	✓ Optional	✗ Not available																

# Helios Master 200/25°



## Helios Master Hobby

\* Aanbieding: geen aanpassingen mogelijk! • Offre avec des options limitées! • Promo-model mit beschränkte Möglichkeiten! • Set package with limited options!

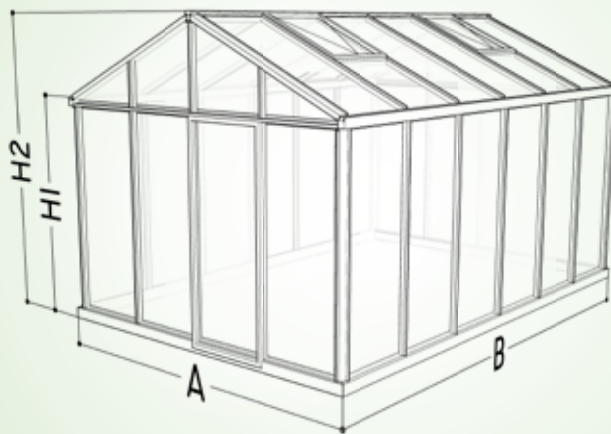
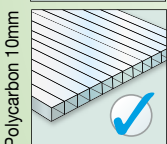
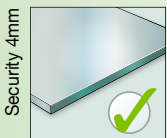

Type	A (cm) x B(cm)	M <sup>2</sup>	H1(cm)	H2(cm)	xx°				
MH23	236 cm x 310 cm	7,3 m <sup>2</sup>	201 cm	260 cm	25 °	1	2	1	
MH24	236 cm x 458 cm	10,8 m <sup>2</sup>	201 cm	260 cm	25 °	1	3	1	
MH34	310 cm x 458 cm	14,2 m <sup>2</sup>	201 cm	274 cm	25 °	1	3	1	
MH36	310 cm x 606 cm	18,8 m <sup>2</sup>	201 cm	274 cm	25 °	1	4	1	
MH46	384 cm x 606 cm	23,3 m <sup>2</sup>	201 cm	278 cm	22 °	2	6	1	

✓ Included    
 ✓ Optional    
 ✗ Not available



# Helios Master Victorian

\* Aanbieding: geen aanpassingen mogelijk! • Offre avec des options limitées! • Promo-model mit beschränkte Möglichkeiten! • Set package with limited options!

Color

RAL  
9005

RAL  
6009

Security 4mm

Polycarbon 10mm

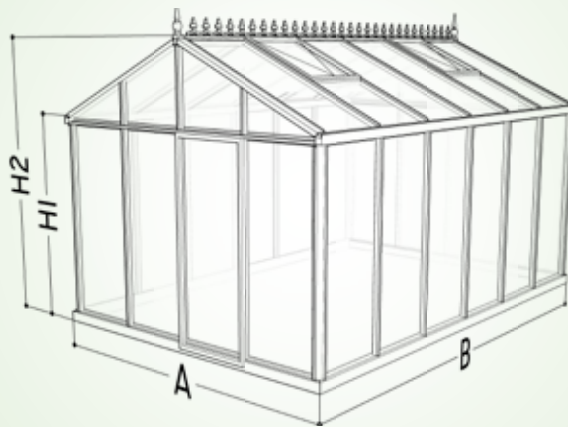

**DIY** Mounting difficulty

EASY 1 2 3 COMPLEX

Type	A (cm) X B(cm)	M <sup>2</sup>	H1(cm)	H2(cm)	xx°			
MV23	236 cm X 310 cm	7,3 m <sup>2</sup>	201 cm	260 cm	25 °	1	2	1
MV24	236 cm X 458 cm	10,8 m <sup>2</sup>	201 cm	260 cm	25 °	1	3	1
MV34	310 cm X 458 cm	14,2 m <sup>2</sup>	201 cm	274 cm	25 °	1	3	1
MV36	310 cm X 606 cm	18,8 m <sup>2</sup>	201 cm	274 cm	25 °	1	4	1
MV46	384 cm X 606 cm	23,3 m <sup>2</sup>	201 cm	278 cm	22 °	2	6	1

✓ Included
✓ Optional
✗ Not available

# Helios 200/25°



## Helios Hobby

Color **ALU (no color)**

Security 4mm

Polycarbon 10mm

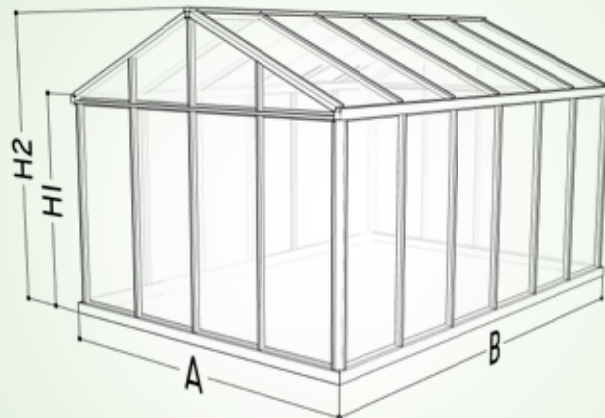

**DIY** Mounting difficulty

EASY T E B COMPLEX

Type	A (cm) X B(cm)	M <sup>2</sup>	H1(cm)	H2(cm)	°xx				
HH22	236 cm X 236 cm	5,6 m <sup>2</sup>	201 cm	260 cm	25 °	-	-	-	-
HH23	236 cm X 310 cm	7,3 m <sup>2</sup>	201 cm	260 cm	25 °	-	-	-	-
HH2E	236 cm X 73 cm	1,7 m <sup>2</sup>	-	-	-	-	-	-	-
HH33	310 cm X 310 cm	9,6 m <sup>2</sup>	201 cm	274 cm	25 °	-	-	-	-
HH34	310 cm X 458 cm	14,2 m <sup>2</sup>	201 cm	274 cm	25 °	-	-	-	-
HH36	310 cm X 606 cm	18,8 m <sup>2</sup>	201 cm	274 cm	25 °	-	-	-	-
HH3E	310 cm X 73 cm	2,3 m <sup>2</sup>	-	-	-	-	-	-	-
HH44	384 cm X 384 cm	14,7 m <sup>2</sup>	201 cm	278 cm	22 °	-	-	-	-
HH45	384 cm X 458 cm	17,6 m <sup>2</sup>	201 cm	278 cm	22 °	-	-	-	-
HH46	384 cm X 606 cm	23,3 m <sup>2</sup>	201 cm	278 cm	22 °	-	-	-	-
HH4E	384 cm X 73 cm	2,8 m <sup>2</sup>	-	-	-	-	-	-	-

Included   
 Optional   
 Not available





# Helios Victorian

Color

RAL  
9005

RAL  
6009

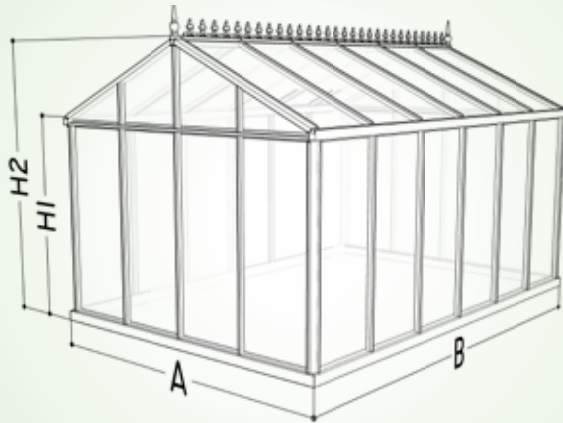
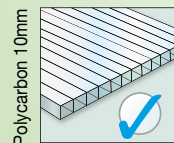
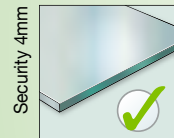

**DIY** Mounting difficulty

EASY 1 2 3 4 5 6 7 8 9 10 COMPLEX

✓ 3

Type	A (cm) X B(cm)	M <sup>2</sup>	H1(cm)	H2(cm)	°xx				
HV22	236 cm X 236 cm	5,6 m <sup>2</sup>	201 cm	260 cm	25 °	-	-	-	-
HV23	236 cm X 310 cm	7,3 m <sup>2</sup>	201 cm	260 cm	25 °	-	-	-	-
HV2E	236 cm X 73 cm	1,7 m <sup>2</sup>	-	-	-	-	-	-	-
HV33	310 cm X 310 cm	9,6 m <sup>2</sup>	201 cm	274 cm	25 °	-	-	-	-
HV34	310 cm X 458 cm	14,2 m <sup>2</sup>	201 cm	274 cm	25 °	-	-	-	-
HV36	310 cm X 606 cm	18,8 m <sup>2</sup>	201 cm	274 cm	25 °	-	-	-	-
HV3E	310 cm X 73 cm	2,3 m <sup>2</sup>	-	-	-	-	-	-	-
HV44	384 cm X 384 cm	14,7 m <sup>2</sup>	201 cm	278 cm	22 °	-	-	-	-
HV45	384 cm X 458 cm	17,6 m <sup>2</sup>	201 cm	278 cm	22 °	-	-	-	-
HV46	384 cm X 606 cm	23,3 m <sup>2</sup>	201 cm	278 cm	22 °	-	-	-	-
HV4E	384 cm X 73 cm	2,8 m <sup>2</sup>	-	-	-	-	-	-	-

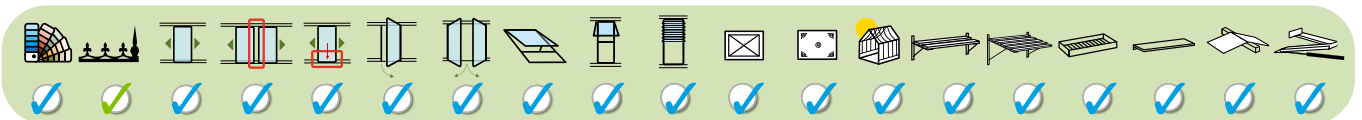

✓ Included    ✓ Optional    ✗ Not available

# Helios 200/25°



## Helios Retro

Color

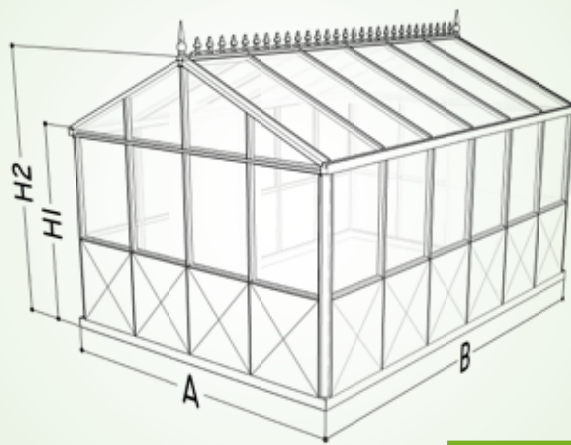
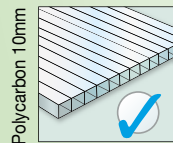
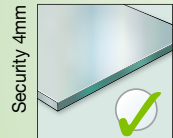
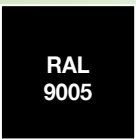

**DIY** Mounting difficulty  
 EASY 1 2 3 COMPLEX

Type	A (cm) X B (cm)	M <sup>2</sup>	H1 (cm)	H2 (cm)	xx°				
------	-----------------	----------------	---------	---------	-----	--	--	--	--

HR22	236 cm X 236 cm	5,6 m <sup>2</sup>	201 cm	260 cm	25 °	-	-	-	-
HR23	236 cm X 310 cm	7,3 m <sup>2</sup>	201 cm	260 cm	25 °	-	-	-	-
HR2E	236 cm X 73 cm	1,7 m <sup>2</sup>	-	-	-	-	-	-	-
HR33	310 cm X 310 cm	9,6 m <sup>2</sup>	201 cm	274 cm	25 °	-	-	-	-
HR34	310 cm X 458 cm	14,2 m <sup>2</sup>	201 cm	274 cm	25 °	-	-	-	-
HR36	310 cm X 606 cm	18,8 m <sup>2</sup>	201 cm	274 cm	25 °	-	-	-	-
HR3E	310 cm X 73 cm	2,3 m <sup>2</sup>	-	-	-	-	-	-	-
HR44	384 cm X 384 cm	14,7 m <sup>2</sup>	201 cm	278 cm	22 °	-	-	-	-
HR45	384 cm X 458 cm	17,6 m <sup>2</sup>	201 cm	278 cm	22 °	-	-	-	-
HR46	384 cm X 606 cm	23,3 m <sup>2</sup>	201 cm	278 cm	22 °	-	-	-	-
HR4E	384 cm X 73 cm	2,8 m <sup>2</sup>	-	-	-	-	-	-	-



✓ Included   
 ✓ Optional   
 ✗ Not available



## Helios Mur

Color

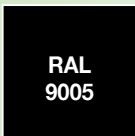

RAL 9005



RAL 6009

Security 4mm

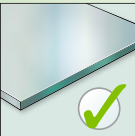

Polycarbon 10mm

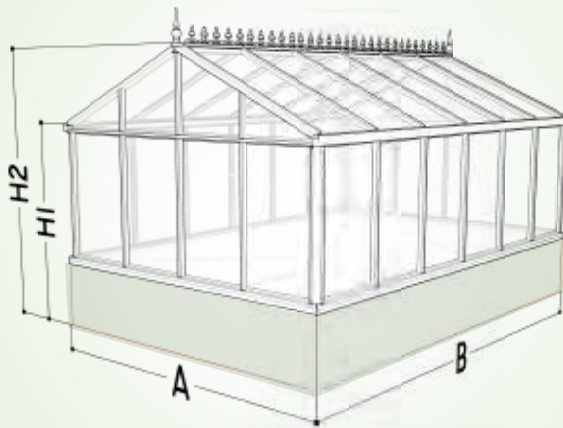
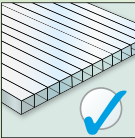

Type	A (cm) X B (cm)	M <sup>2</sup>	H1 (cm)	H2 (cm)	xx°			
HM22	236 cm X 236 cm	5,6 m <sup>2</sup>	201 cm	260 cm	25 °	-	-	-
HM23	236 cm X 310 cm	7,3 m <sup>2</sup>	201 cm	260 cm	25 °	-	-	-
HM2E	236 cm X 73 cm	1,7 m <sup>2</sup>	-	-	-	-	-	-
HM33	310 cm X 310 cm	9,6 m <sup>2</sup>	201 cm	274 cm	25 °	-	-	-
HM34	310 cm X 458 cm	4,2 m <sup>2</sup>	201 cm	274 cm	25 °	-	-	-
HM36	310 cm X 606 cm	18,8 m <sup>2</sup>	201 cm	274 cm	25 °	-	-	-
HM3E	310 cm X 73 cm	2,3 m <sup>2</sup>	-	-	-	-	-	-
HM44	384 cm X 384 cm	14,7 m <sup>2</sup>	201 cm	278 cm	22 °	-	-	-
HM45	384 cm X 458 cm	17,6 m <sup>2</sup>	201 cm	278 cm	22 °	-	-	-
HM46	384 cm X 606 cm	23,3 m <sup>2</sup>	201 cm	278 cm	22 °	-	-	-
HM4E	384 cm X 73 cm	2,8 m <sup>2</sup>	-	-	-	-	-	-

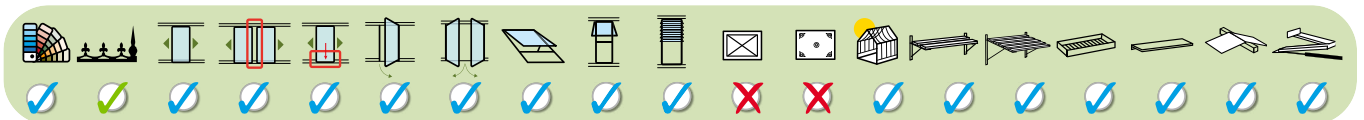

Included

Optional

Not available

# Helios 200/25°



## Helios T•Model

Color

RAL  
9005

RAL  
6009

Security 4mm

Polycarbon 10mm

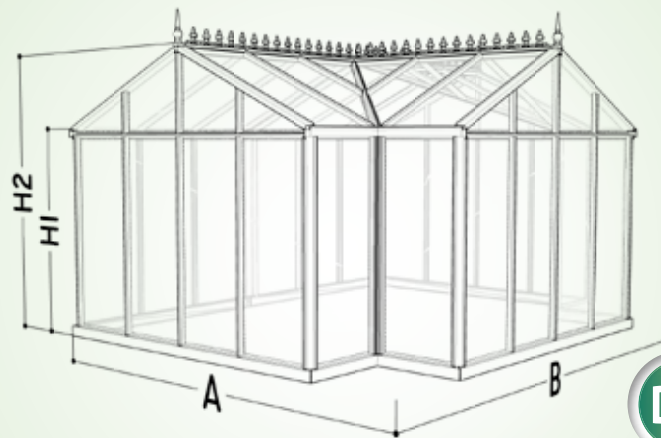

**DIY** Mounting difficulty

EASY 1 2 3 COMPLEX

✓

Type	A (cm) X B(cm)	M <sup>2</sup>	H1(cm)	H2(cm)	xx°				
HT34	392 cm x 476 cm	18,7 m <sup>2</sup>	201 cm	274 cm	25 °	-	-	-	-
HT3E	310 cm x 73 cm	2,3 m <sup>2</sup>	-	-	-	-	-	-	-

✓ Included
✓ Optional
✗ Not available



# Helios Twin 200/25°



## Helios Twin

Bemating: zie Helios (2 x A)

Dimensions: See Helios (2 x A)

Dimensions: Voir Helios (2 x A)

Abmessungen: Sehe Helios (2 x A)

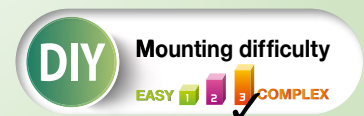
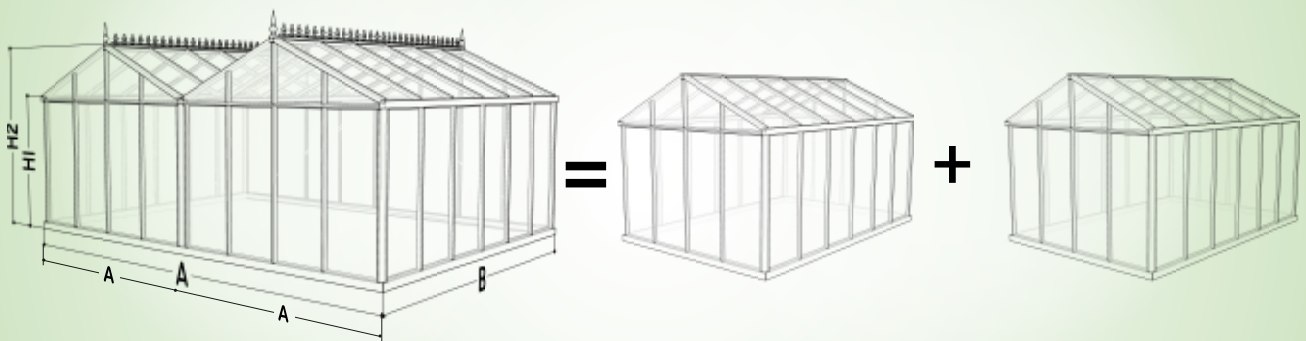



# Arcadia Lean To



## Arcadia **Hobby**

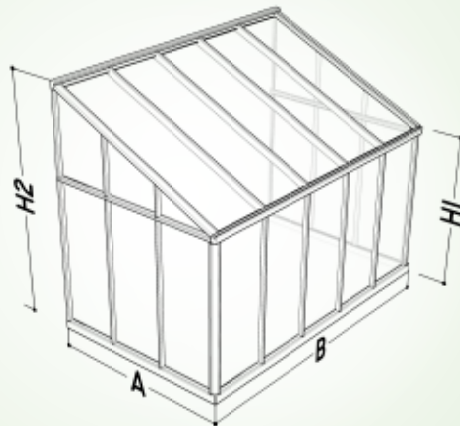
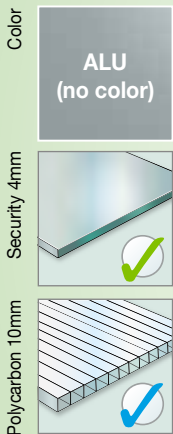

Type	A (cm) X B(cm)	M <sup>2</sup>	H1(cm)	H2(cm)	xx°			
AH01	82 cm X 160 cm	1,3 m <sup>2</sup>	201 cm	242 cm	25 °	-	-	-
AH03	82 cm X 310 cm	2,5 m <sup>2</sup>	201 cm	242 cm	25 °	-	-	-
AH04	82 cm X 458 cm	3,8 m <sup>2</sup>	201 cm	242 cm	25 °	-	-	-
AH0E	82 cm X 73 cm	0,6 m <sup>2</sup>	-	-	-	-	-	-
AH11	157 cm X 160 cm	2,5 m <sup>2</sup>	201 cm	279 cm	26 °	-	-	-
AH13	157 cm X 310 cm	4,9 m <sup>2</sup>	201 cm	279 cm	26 °	-	-	-
AH14	157 cm X 458 cm	7,2 m <sup>2</sup>	201 cm	279 cm	26 °	-	-	-
AH1E	157 cm X 73 cm	1,1 m <sup>2</sup>	-	-	-	-	-	-

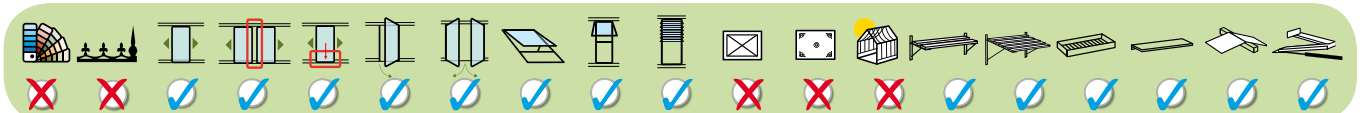

Included   
 Optional   
 Not available



# 200/25°



## Arcadia **Victorian**

Color

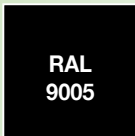

Security 4mm

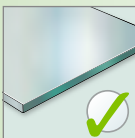

Polycarbon 10mm

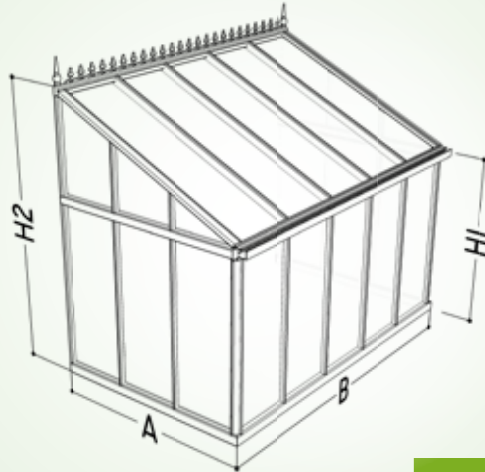
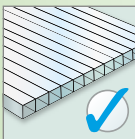

**DIY** Mounting difficulty  
 EASY 1 2 3 COMPLEX

Type	A (cm) X B(cm)	M <sup>2</sup>	H1(cm)	H2(cm)	xx°			
AV01	82 cm X 160 cm	1,3 m <sup>2</sup>	201 cm	242 cm	25 °	-	-	-
AV03	82 cm X 310 cm	2,5 m <sup>2</sup>	201 cm	242 cm	25 °	-	-	-
AV04	82 cm X 458 cm	3,8 m <sup>2</sup>	201 cm	242 cm	25 °	-	-	-
AV0E	82 cm X 73 cm	0,6 m <sup>2</sup>	-	-	-	-	-	-
AV11	157 cm X 160 cm	2,5 m <sup>2</sup>	201 cm	279 cm	26 °	-	-	-
AV13	157 cm X 310 cm	4,9 m <sup>2</sup>	201 cm	279 cm	26 °	-	-	-
AV14	157 cm X 458 cm	7,2 m <sup>2</sup>	201 cm	279 cm	26 °	-	-	-
AV1E	157 cm X 73 cm	1,1 m <sup>2</sup>	-	-	-	-	-	-

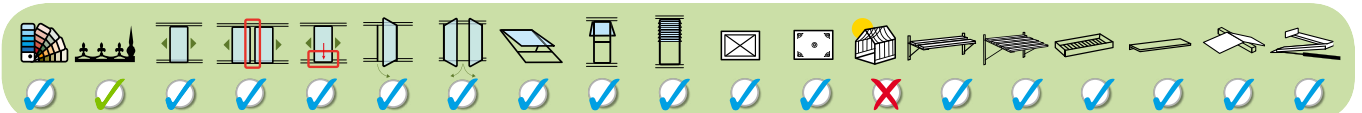

Included   
 Optional   
 Not available

# Arcadia Lean To



## Arcadia Retro

Color

**RAL 9005** **RAL 6009**

Security 4mm

Polycarbon 10mm

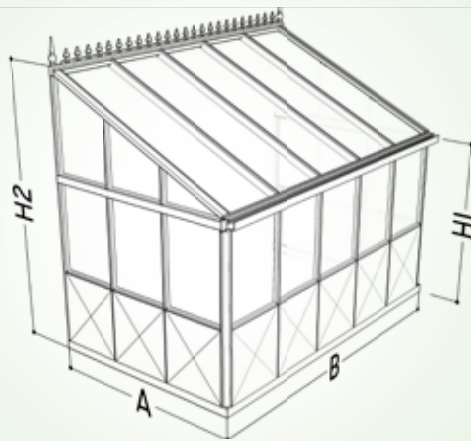

DECOR1

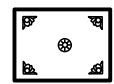

DECOR2

**DIY** Mounting difficulty

EASY 1 2 3 COMPLEX

Type	A (cm) X B(cm)	M <sup>2</sup>	H1 (cm)	H2(cm)	xx°				
------	----------------	----------------	---------	--------	-----	--	--	--	--

AR01	82 cm X 160 cm	1,3 m <sup>2</sup>	201 cm	242 cm	25 °	-	-	-	-
AR03	82 cm X 310 cm	2,5 m <sup>2</sup>	201 cm	242 cm	25 °	-	-	-	-
AR04	82 cm X 458 cm	3,8 m <sup>2</sup>	201 cm	242 cm	25 °	-	-	-	-
AR0E	82 cm X 73 cm	0,6 m <sup>2</sup>	-	-	-	-	-	-	-
AR11	157 cm X 160 cm	2,5 m <sup>2</sup>	201 cm	279 cm	26 °	-	-	-	-
AR13	157 cm X 310 cm	4,9 m <sup>2</sup>	201 cm	279 cm	26 °	-	-	-	-
AR14	157 cm X 458 cm	7,2 m <sup>2</sup>	201 cm	279 cm	26 °	-	-	-	-
AR1E	157 cm X 73 cm	1,1 m <sup>2</sup>	-	-	-	-	-	-	-



✓ Included    ✓ Optional    ✗ Not available

# 200/25°



## Arcadia Mur

Color

RAL  
9005

RAL  
6009

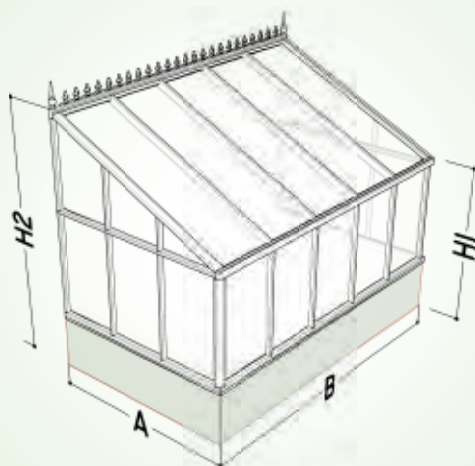
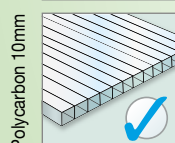
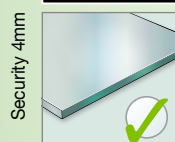

**DIY** Mounting difficulty

EASY 1 2 3 COMPLEX

Type	A (cm) X B(cm)	M <sup>2</sup>	H1 (cm)	H2(cm)	xx°			
------	----------------	----------------	---------	--------	-----	--	--	--

AM01	82 cm X 160 cm	1,3 m <sup>2</sup>	201 cm	242 cm	25 °	-	-	-
AM03	82 cm X 310 cm	2,5 m <sup>2</sup>	201 cm	242 cm	25 °	-	-	-
AM04	82 cm X 458 cm	3,8 m <sup>2</sup>	201 cm	242 cm	25 °	-	-	-
AM0E	82 cm X 73 cm	0,6 m <sup>2</sup>	-	-	-	-	-	-
AM11	157 cm X 160 cm	2,5 m <sup>2</sup>	201 cm	279 cm	26 °	-	-	-
AM13	157 cm X 310 cm	4,9 m <sup>2</sup>	201 cm	279 cm	26 °	-	-	-
AM14	157 cm X 458 cm	7,2 m <sup>2</sup>	201 cm	279 cm	26 °	-	-	-
AM1E	157 cm X 73 cm	1,1 m <sup>2</sup>	-	-	-	-	-	-

✓ Included    
 ✓ Optional    
 ✗ Not available

# Arcadia Lean To



## Arcadia Plus Victorian

Color



Security 4mm

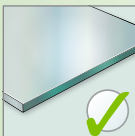

Polycarbon 10mm

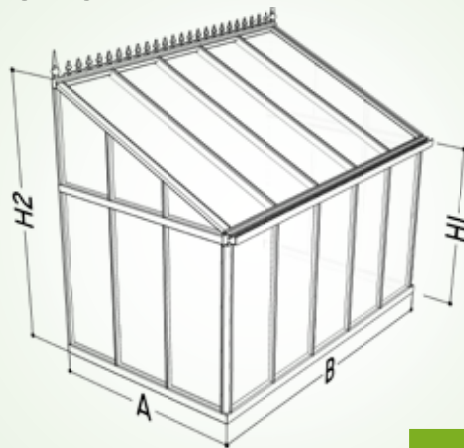
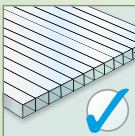

**DIY** Mounting difficulty  
 EASY 1 2 3 COMPLEX

Type	A (cm) x B (cm)	M <sup>2</sup>	H1 (cm)	H2 (cm)	xx°	Icon 1	Icon 2	Icon 3
------	-----------------	----------------	---------	---------	-----	--------	--------	--------

APV01	82 cm x 160 cm	1,3 m <sup>2</sup>	204 cm	232-254 cm	15-30 °	-	-	-
APV03	82 cm x 310 cm	2,5 m <sup>2</sup>	204 cm	232-254 cm	15-30 °	-	-	-
APV04	82 cm x 458 cm	3,8 m <sup>2</sup>	204 cm	232-254 cm	15-30 °	-	-	-
APV0E	82 cm x 73 cm	0,6 m <sup>2</sup>	-	-	-	-	-	-
APV11	157 cm x 160 cm	2,5 m <sup>2</sup>	204 cm	251-296 cm	15-30 °	-	-	-
APV13	157 cm x 310 cm	4,9 m <sup>2</sup>	204 cm	251-296 cm	15-30 °	-	-	-
APV14	157 cm x 458 cm	7,2 m <sup>2</sup>	204 cm	251-296 cm	15-30 °	-	-	-
APV1E	157 cm x 73 cm	1,1 m <sup>2</sup>	-	-	-	-	-	-
APV23	230 cm x 310 cm	7,1 m <sup>2</sup>	204 cm	271- 341 cm	15-30 °	-	-	-
APV24	230 cm x 458 cm	10,5 m <sup>2</sup>	204 cm	271- 341 cm	15-30 °	-	-	-
APV26	230 cm x 606 cm	13,9 m <sup>2</sup>	204 cm	271- 341 cm	15-30 °	-	-	-
APV2E	230 cm x 73 cm	1,6 m <sup>2</sup>	-	-	-	-	-	-
APV33	305 cm x 310 cm	9,5 m <sup>2</sup>	204 cm	291-381 cm	15-30 °	-	-	-
APV34	305 cm x 458 cm	14 m <sup>2</sup>	204 cm	291-381 cm	15-30 °	-	-	-
APV36	305 cm x 606 cm	18,5 m <sup>2</sup>	204 cm	291-381 cm	15-30 °	-	-	-
APV3E	305 cm x 73 cm	2,2 m <sup>2</sup>	-	-	-	-	-	-



✓ Included    ✓ Optional    X Not available

# 200/15° - 30°



## Arcadia Plus Retro

Color

RAL  
9005

RAL  
6009

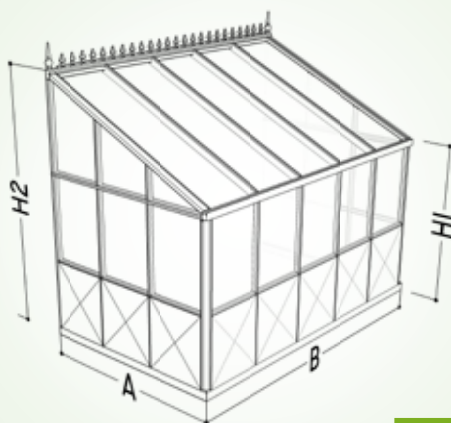
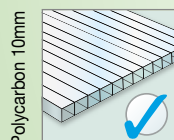
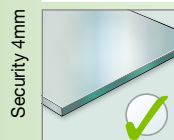

**DIY** Mounting difficulty

EASY 1 2 3 COMPLEX

Type	A (cm) X B (cm)	M <sup>2</sup>	H1 (cm)	H2 (cm)	xx°			
APR01	82 cm X 160 cm	1,3 m <sup>2</sup>	204 cm	232-254 cm	15-30 °	-	-	-
APR03	82 cm X 310 cm	2,5 m <sup>2</sup>	204 cm	232-254 cm	15-30 °	-	-	-
APR04	82 cm X 458 cm	3,8 m <sup>2</sup>	204 cm	232-254 cm	15-30 °	-	-	-
APR0E	82 cm X 73 cm	0,6 m <sup>2</sup>	-	-	-	-	-	-
APR11	157 cm X 160 cm	2,5 m <sup>2</sup>	204 cm	251-296 cm	15-30 °	-	-	-
APR13	157 cm X 310 cm	4,9 m <sup>2</sup>	204 cm	251-296 cm	15-30 °	-	-	-
APR14	157 cm X 458 cm	7,2 m <sup>2</sup>	204 cm	251-296 cm	15-30 °	-	-	-
APR1E	157 cm X 73 cm	1,1 m <sup>2</sup>	-	-	-	-	-	-
APR23	230 cm X 310 cm	7,1 m <sup>2</sup>	204 cm	271- 341 cm	15-30 °	-	-	-
APR24	230 cm X 458 cm	10,5 m <sup>2</sup>	204 cm	271- 341 cm	15-30 °	-	-	-
APR26	230 cm X 606 cm	13,9 m <sup>2</sup>	204 cm	271- 341 cm	15-30 °	-	-	-
APR2E	230 cm X 73 cm	1,6 m <sup>2</sup>	-	-	-	-	-	-
APR33	305 cm X 310 cm	9,5 m <sup>2</sup>	204 cm	291-381 cm	15-30 °	-	-	-
APR34	305 cm X 458 cm	14 m <sup>2</sup>	204 cm	291-381 cm	15-30 °	-	-	-
APR36	305 cm X 606 cm	18,5 m <sup>2</sup>	204 cm	291-381 cm	15-30 °	-	-	-
APR3E	305 cm X 73 cm	2,2 m <sup>2</sup>	-	-	-	-	-	-

Legend for icons: ✓ Included, ✓ Optional, ✗ Not available

# Arcadia Lean To



## Arcadia Plus Mur

Color

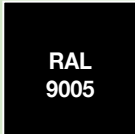

Security 4mm

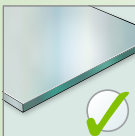

Polycarbon 10mm

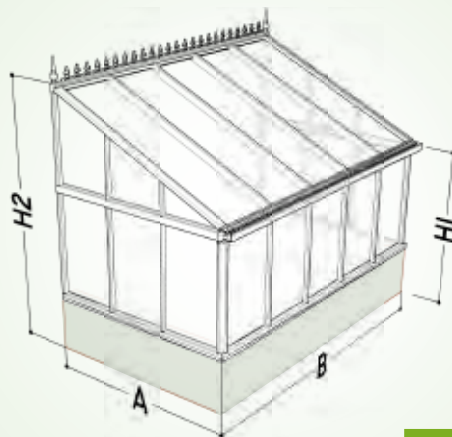
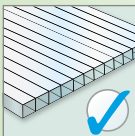

**DIY** Mounting difficulty  
 EASY 1 2 3 COMPLEX

Type	A (cm) X B(cm)	M <sup>2</sup>	H1(cm)	H2(cm)	xx°				
APM01	82 cm X 160 cm	1,3 m <sup>2</sup>	204 cm	232-254 cm	15-30 °	-	-	-	-
APM03	82 cm X 310 cm	2,5 m <sup>2</sup>	204 cm	232-254 cm	15-30 °	-	-	-	-
APM04	82 cm X 458 cm	3,8 m <sup>2</sup>	204 cm	232-254 cm	15-30 °	-	-	-	-
APM0E	82 cm X 73 cm	0,6 m <sup>2</sup>	-	-	-	-	-	-	-
APM11	157 cm X 160cm	2,5 m <sup>2</sup>	204 cm	251-296 cm	15-30 °	-	-	-	-
APM13	157 cm X 310cm	4,9 m <sup>2</sup>	204 cm	251-296 cm	15-30 °	-	-	-	-
APM14	157 cm X 458cm	7,2 m <sup>2</sup>	204 cm	251-296 cm	15-30 °	-	-	-	-
APM1E	157 cm X 73 cm	1,1 m <sup>2</sup>	-	-	-	-	-	-	-
APM23	230 cm X 310cm	7,1 m <sup>2</sup>	204 cm	271- 341cm	15-30 °	-	-	-	-
APM24	230 cm X 458cm	10,5 m <sup>2</sup>	204 cm	271- 341cm	15-30 °	-	-	-	-
APM26	230 cm X 606cm	13,9 m <sup>2</sup>	204 cm	271- 341cm	15-30 °	-	-	-	-
APM2E	230 cm X 73 cm	1,6 m <sup>2</sup>	-	-	-	-	-	-	-
APM33	305 cm X 310cm	9,5 m <sup>2</sup>	204 cm	291-381 cm	15-30 °	-	-	-	-
APM34	305 cm X 458 cm	14 m <sup>2</sup>	204 cm	291-381 cm	15-30 °	-	-	-	-
APM36	305 cm X 606 cm	18,5 m <sup>2</sup>	204 cm	291-381 cm	15-30 °	-	-	-	-
APM3E	305 cm X 73 cm	2,2 m <sup>2</sup>	-	-	-	-	-	-	-



✓ Included    ✓ Optional    ✗ Not available

200/15° - 30°



# Professional Pavillons



## Pavillons **Pyramide**

Color

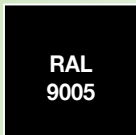

Security 4mm

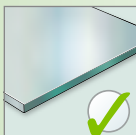

Polycarbon 10mm

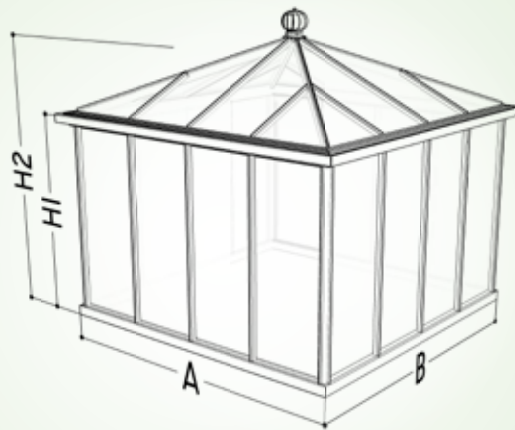
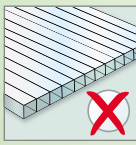

**DIY** Mounting difficulty

EASY 1 2 3 COMPLEX

Type	A (cm) X B(cm)	M <sup>2</sup>	H1(cm)	H2(cm)	°xx			
PYR310	310 cm x 310 cm	9,6m <sup>2</sup>	204 cm	277/307 cm	25 °	-	-	-
PYR378	380 cm x 380 cm	14,4m <sup>2</sup>	204 cm	294/324 cm	25 °	-	-	-

✓	✗	✓	✓	✓	✓	✗	✓	✓	✗	✗	✗	✗	✗	✗	✗	✓	✓	✓
✓ Included		✓ Optional				✗ Not available												





# Professional Pavillons



## Pavillons Carrousel A

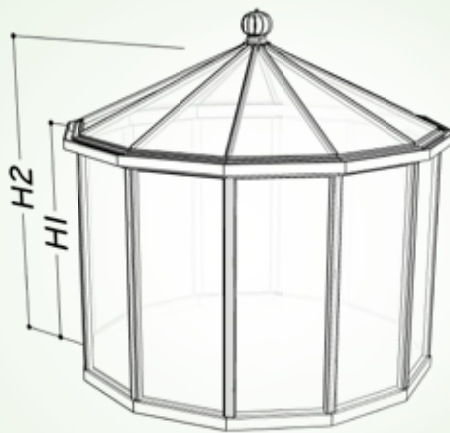
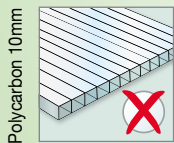
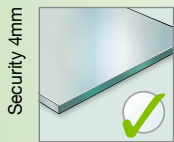
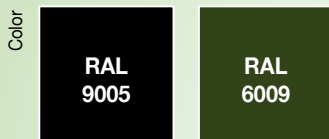

Type	Diameter (cm)	M <sup>2</sup>	H1(cm)	H2(cm)	°XX	Icon 1	Icon 2	Icon 3	Icon 4
CARA310	310 cm	7,5 m <sup>2</sup>	204 cm	277/307cm	25 °	-	-	-	-
CARA378	378 cm	11,2 m <sup>2</sup>	204 cm	281/311 cm	25 °	-	-	-	-
CARE	73 cm	2,3 m <sup>2</sup>	-	-	-	-	-	-	-

## Pavillons Carrousel B

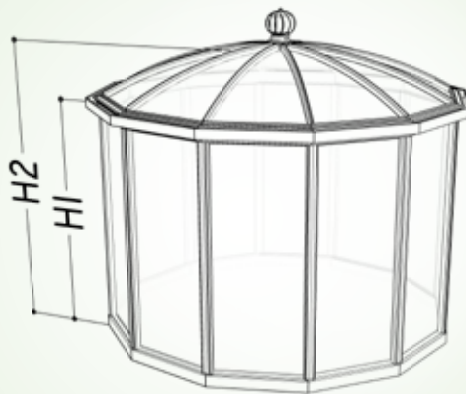
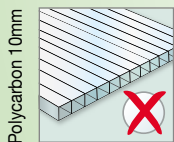
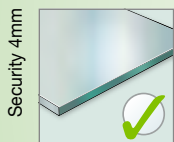

Type	Diameter (cm)	M <sup>2</sup>	H1(cm)	H2(cm)	°XX	Icon 1	Icon 2	Icon 3	Icon 4
CARB310	310 cm	7,5 m <sup>2</sup>	204 cm	247/277cm	25 °	-	-	-	-
CARB378	378 cm	11,2 m <sup>2</sup>	204 cm	270/300 cm	25 °	-	-	-	-
CARE	73 cm	2,3 m <sup>2</sup>	-	-	-	-	-	-	-

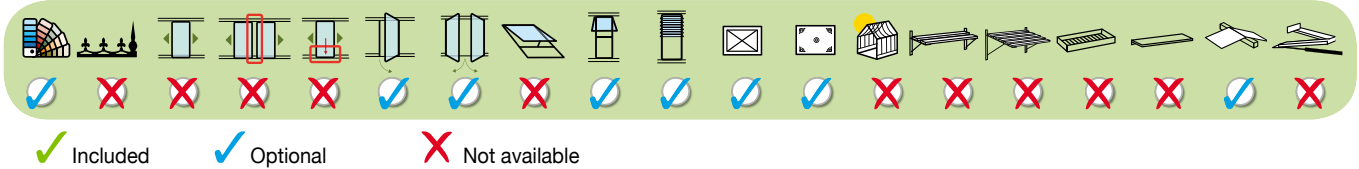

# Professional



## Custom **Kathedral**

Color

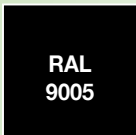

Security 4mm

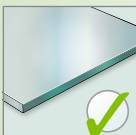

Polycarbon 10mm

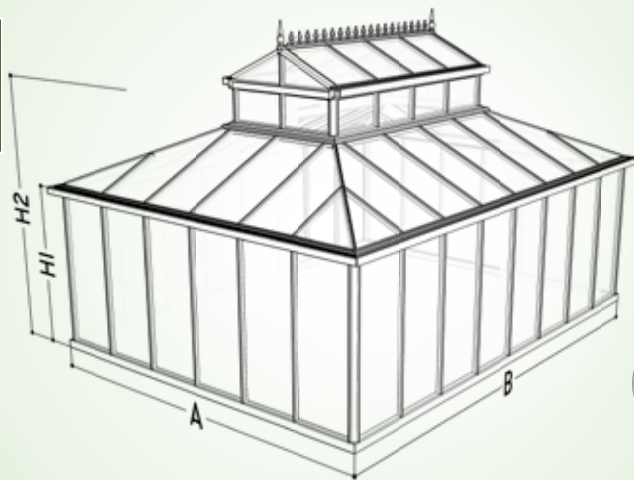
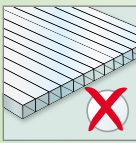

**DIY** Mounting difficulty  
 EASY 1 2 3 COMPLEX

Type	A (cm) x B(cm)	M <sup>2</sup>	H1 (cm)	H2 (cm)	°xx			
KAT46	458 cm x 606 cm	27,8m <sup>2</sup>	204 cm	267/370 cm	25 °	-	-	-
KATE	458 cm x 73 cm	3,3m <sup>2</sup>	-	-	-	-	-	-

Included    Optional    Not available



## Custom Modern

Color

RAL  
9005

RAL  
6009

Security 4mm

Polycarbon 10mm

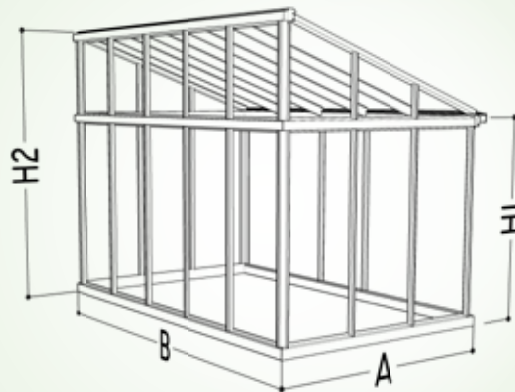

**DIY** Mounting difficulty

EASY 1 2 3 COMPLEX

Type	A (cm) X B(cm)	M <sup>2</sup>	H1 (cm)	H2(cm)				
M23	236 cm X 236 cm	5,6m <sup>2</sup>	204 cm	270 cm	15 °	-	-	-
M2E	236 cm X 73 cm	1,7m <sup>2</sup>	-	-	-	-	-	-
M33	310 cm X 310 cm	9,6m <sup>2</sup>	204 cm	292 cm	15 °	-	-	-
M3E	310 cm X 73 cm	2,3m <sup>2</sup>	-	-	-	-	-	-

✓ Included     
 ✓ Optional     
 ✗ Not available

# Professional



## Custom Gigant Hobby

Color  
**ALU**  
 (no color)

Security 4mm

Polycarbon 10mm

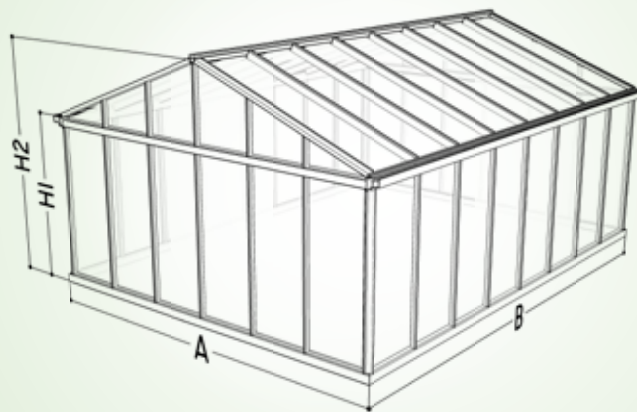

**DIY** Mounting difficulty  
 EASY 1 2 3 COMPLEX

Type	A (cm) X B(cm)	M <sup>2</sup>	H1(cm)	H2(cm)	°XX	Icon 1	Icon 2	Icon 3	Icon 4
GH44	457 cm X 457cm	20,9m <sup>2</sup>	204 cm	300cm	25 °	-	-	-	-
GH4E	457 cm X 73 cm	3,3m <sup>2</sup>	-	-	-	-	-	-	-
GH55	531 cm X 531cm	28,2m <sup>2</sup>	204 cm	315 cm	25 °	-	-	-	-
GH5E	531 cm X 73 cm	3,9m <sup>2</sup>	-	-	-	-	-	-	-
GH66	606 cm X 606cm	36,7m <sup>2</sup>	204 cm	331 cm	22 °	-	-	-	-
GH6E	606 cm X 73 cm	4,4m <sup>2</sup>	-	-	-	-	-	-	-

✓ Included    ✓ Optional    ✗ Not available



## Custom **Gigant Victorian**

Color

RAL  
9005

RAL  
6009

Security 4mm

Polycarbon 10mm

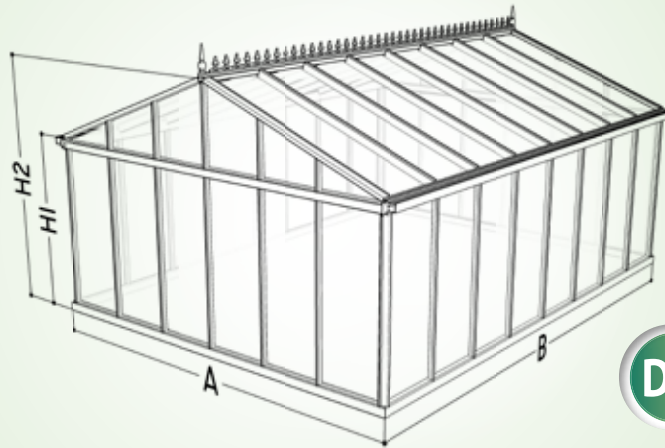

**DIY** Mounting difficulty

EASY 1 2 3 COMPLEX

✓

Type	A (cm) X B (cm)	M <sup>2</sup>	H1 (cm)	H2 (cm)	°XX			
GV44	457 cm X 457 cm	20,9m <sup>2</sup>	204 cm	300cm	25 °	-	-	-
GV4E	457 cm X 73 cm	3,3m <sup>2</sup>	-	-	-	-	-	-
GV55	531 cm X 531 cm	28,2m <sup>2</sup>	204 cm	315 cm	25 °	-	-	-
GV5E	531 cm X 73 cm	3,9m <sup>2</sup>	-	-	-	-	-	-
GV66	606 cm X 606 cm	36,7m <sup>2</sup>	204 cm	331 cm	22 °	-	-	-
GV6E	606 cm X 73 cm	4,4m <sup>2</sup>	-	-	-	-	-	-

✓ Included    
 ✓ Optional    
 ✗ Not available

# Professional Orangerie

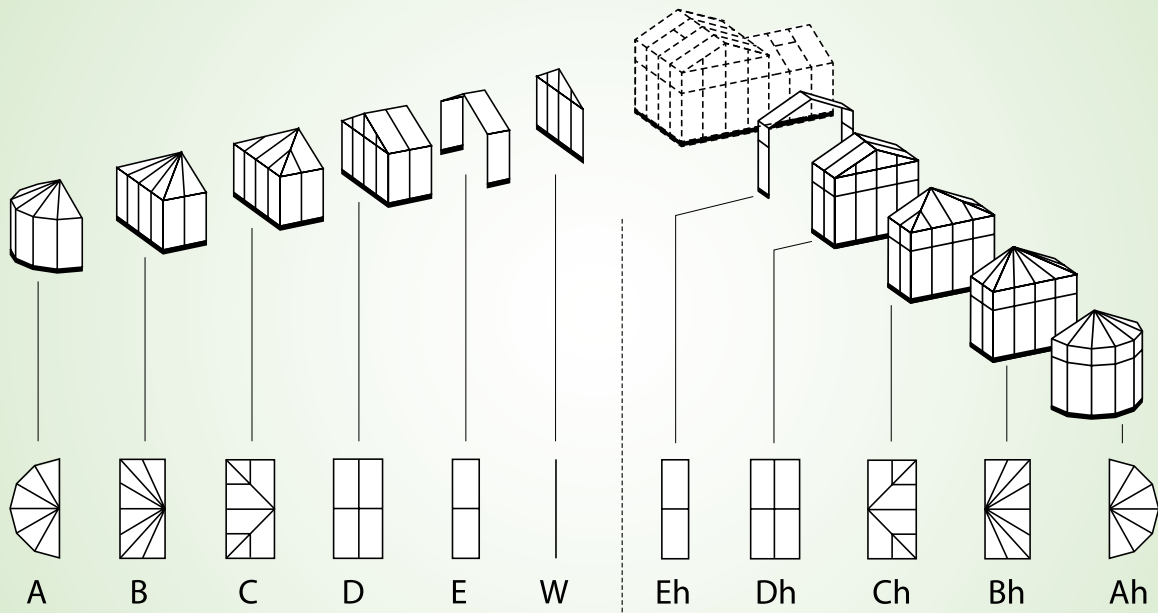

















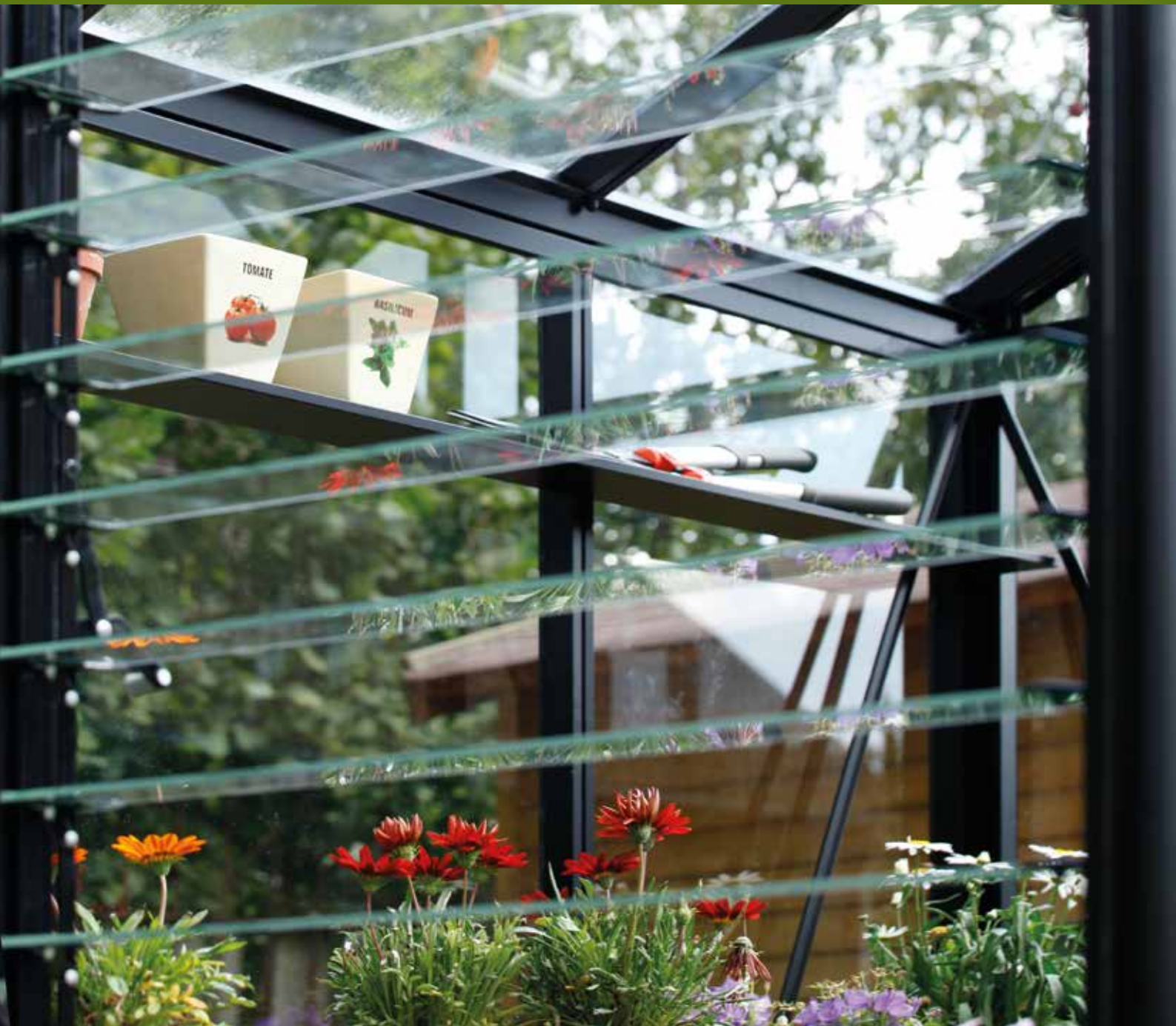

Verdeler – Distributor – Distributeur – Händler:

Janssens NV | Mechelsesteenweg 388 | B-2500 Lier | Belgium  
Tel +32 (0) 15 30 67 80 | [www.janssens-alusystems.be](http://www.janssens-alusystems.be) | [info@janssens-alusystems.be](mailto:info@janssens-alusystems.be)